

Guidance for Load Factor Rating (LFR) for Corrugated Metal Structures

The guidances provided herein are applicable to corrugated metal structures (steel and aluminum) and structural plate box culverts buried in the soil. The guidances are divided into two parts, viz. Part A and Part B.

Part A guidance is applicable to the following structure types:

1. **Corrugated Metal Pipe** as described in AASHTO Standard Specifications for Highway Bridges, 17th edition, section no. 12.4.
2. **Spiral Rib Metal Pipe** as described in AASHTO Standard Specifications, section no. 12.5.
3. **Structural Plate Pipe Structures** as described in AASHTO Standard Specifications, section no. 12.6.
4. **Long Span Structural Plate Structures** as described in AASHTO Standard Specifications, section no. 12.7.

AASHTO Standard Specifications, section no. 12.4 through 12.7 are attached as Appendix I at the end of **Part B guidance**.

Part B guidance is applicable to the following structure type:

1. **Structural Plate Box Culverts** as described in AASHTO Standard Specifications, section no. 12.8.

AASHTO Standard Specifications, section no. 12.8 is attached as Appendix II at the end of **Part B guidance**.

Part A Guidance

Use the Existing Bridge Plans and/or Field Measurements to find the following Structural Dimensions:

1. Find the following structural dimensions as shown in Figure 1:

H_1 = Fill Depth at Centerline of Roadway in ft

H_2 = Fill Depth at Edge of Pavement in ft

S = Span Length in ft

R = Rise in ft

L = Longitudinal Length of Structure in ft

R_t = Actual Top Radius in ft (See Figure 1 and section 4 for further details)

2. Find the following Metal Corrugation & Gage Information as shown in Figure 1:

Metal Type Steel or Aluminum

Corrugation c (in) = pitch

d (in) = depth

t (in) = thickness of corrugated metal

Pipe Crown Deflection in inches

Metal thicknesses in inches in the most corroded part of the pipe/structure. Then calculate $\Phi_{loss} = (A_s \text{ inspected} \times \text{sectional Area in in}^2 / \text{Original X sectional Area in in}^2)$ for 1 ft strip in the longitudinal direction.

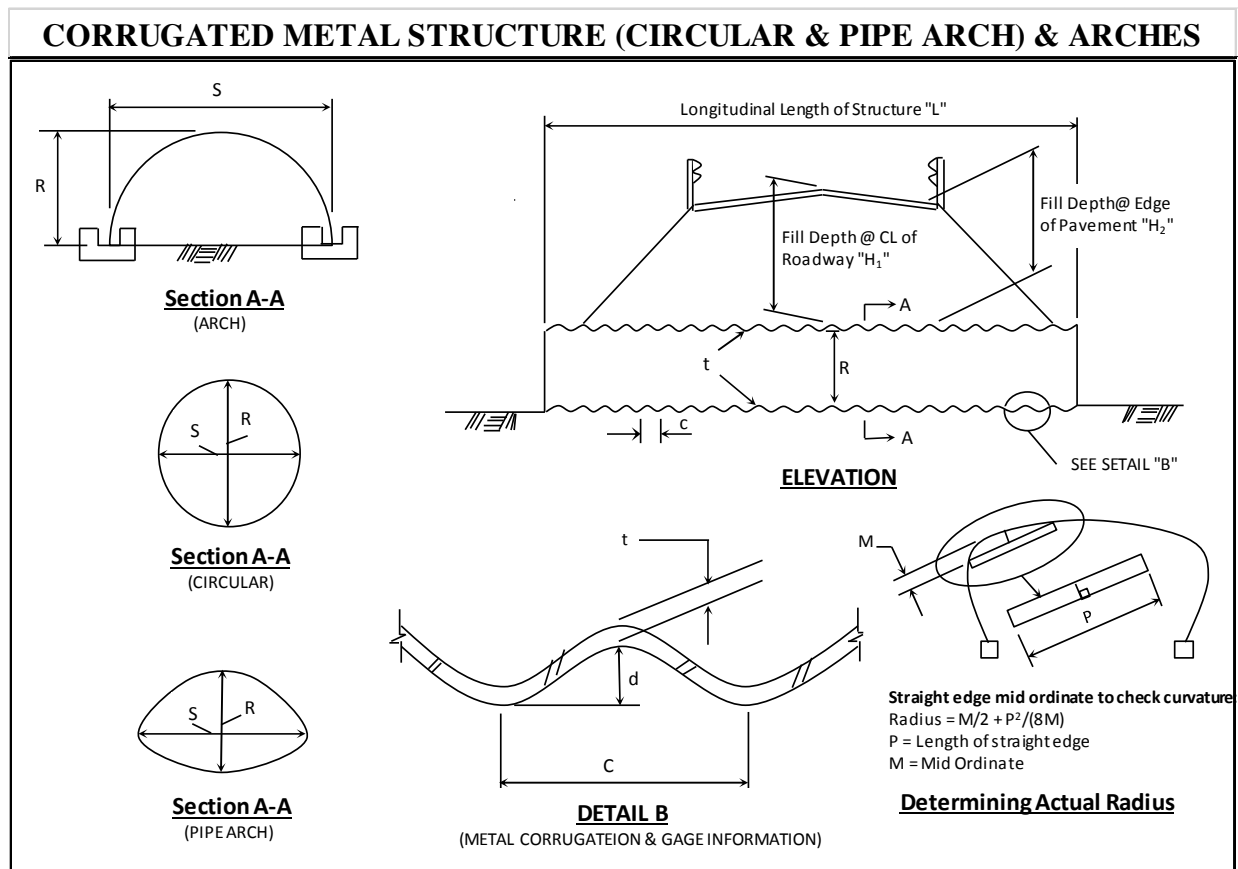

* For unsymmetrical structures, structures deflected more than 5% from design shape, or those that show localized distortions require that the actual maximum radius be determined in those distorted areas as show above. Use two times the actual maximum radius rather than the span in structural design checks. Typically this provides a conservative evaluation of the structure. Calculate maximum existing top radius by taking measurements around the upper periphery of the culvert using a ruler of length "P" to obtain values of "M". This should be done at selected stations along length of culvert, particularly at locations with noticeable sag.

Figure 1 – Corrugated Metal Structure (Circular and Pipe Culverts)

3. Check if the seam type is spot welded, riveted or bolted. If Yes, obtain longitudinal Seam Strength from **Table 1** provided in next page (page no. 4).
4. Categorise the Structure into two categories – Category i) **Typical Structure** – Symmetric structures deflected less than or equal to 5% of the diameter of the pipe from design shape.
or Category ii) **Unsymmetrical Structures or Structures deflected over 5%** of the diameter of the pipe from design shape.

For category I, use the actual span as Span S in calculations.

For category ii, a. Determine the top radius R_t as follows: Measure the chord length at top, P between the point of curve on the vertical leg of the structure to point of tangency on the horizontal leg of the structure using a ruler (see Figure 1). Measure the middle ordinate at the upper periphery of the structure, M at the midpoint of the chord. Then calculate the top radius R_t by the formula, $R_t = M/2 + P^2/(8M)$. Then Use two times the top radius ($2R_t$) as Span S for calculations.

b. Critical buckling stress: For unsymmetrical sections, reduce the critical buckling stress by an appropriate factor obtained from **Figure 2**.

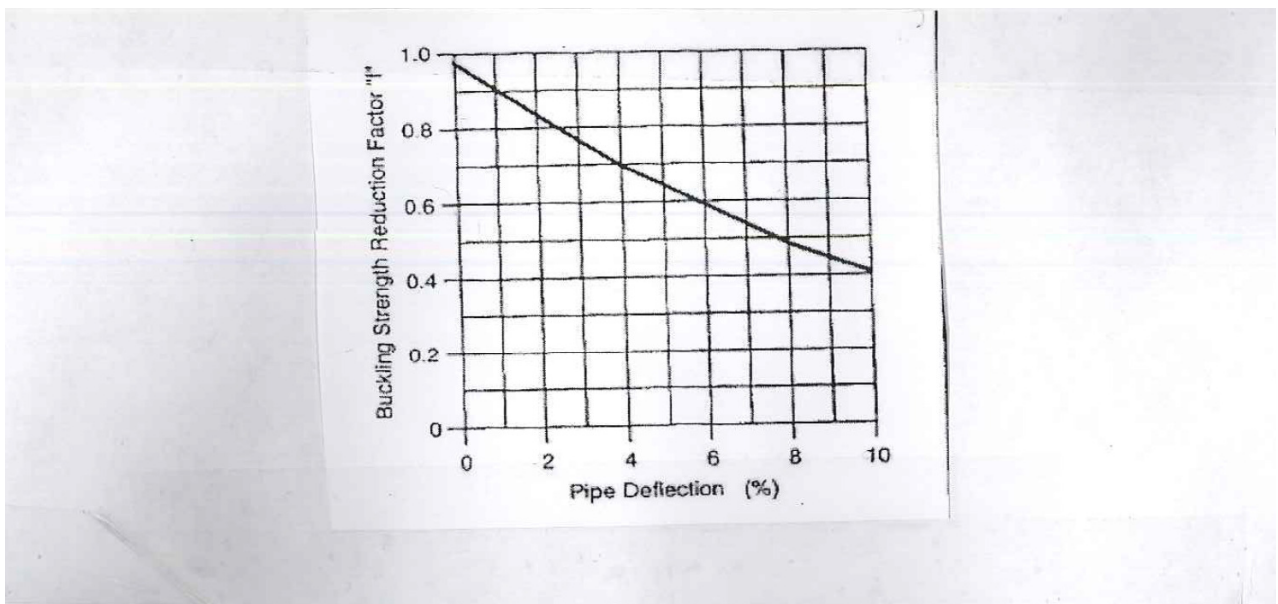

Figure 2 – Reduction Factor for Buckling Strength (I) Due to Deflection in Round Pipe

5. Find the following Mechanical & Section Properties from as-built plans or AASHTO standard sections 12.4 through 12.7. (For further information, refer to the Appendix 1)

F_Y = Minimum Yield Point of the Metal in ksi

F_U = Minimum Tensile Strength of the Metal in ksi

E_m = Modulus of Elasticity of the Metal in ksi

A_s = Cross-Sectional Area of the Pipe for 1 ft strip in the longitudinal direction in in^2/ft

I = Moment of inertia of the Pipe for 1 ft strip in the longitudinal direction in in^4/ft

r = Radius of Gyration of the Corrugation in inches

Φ_{loss} = Section properties reduction factor on basis of metal loss from the materials field evaluation (from section 2, page 2)

Φ_1 = Capacity modification factor for wall area and buckling (for further information, refer to Appendix 1)

Φ_2 = Capacity modification factor for seam strength (for further information, refer to Appendix 1)

δ = Soil density (k/ft^3)

k = Soil stiffness factor = 0.22 (from AASHTO section 12.3.2)

6. Perform the following Calculations:

- A. Calculate the F_{cr} (critical buckling stress):

If: $S < (r/k)\sqrt{(24E_m/F_U)}$, then $F_{cr} = F_U - (F_U^2/48E_m)(kS/r)^2$

If: $S > (r/k)\sqrt{(24E_m/F_U)}$, then $F_{cr} = 12E_m/(kS/r)^2$

f = Buckling Strength reduction factor

= 1.0 for Category i) Typical Structures

= $0.95 - 5.6x$ % deflection at crown for Category ii Structures

B. Calculate the T_{cap} (thrust capacity of the wall) as the least of the following three quantities:

- i. wall yield strength = $\Phi_1 \Phi_{loss} F_y A_s$
- ii. wall buckling strength = $\Phi_1 \Phi_{loss} f F_{cr} A_s$
- iii. seam strength = $\Phi_2 \times$ (seam strength) where the seam strength value is based on metal type, corrugation, gage number or pipe wall thickness as shown in Table 1

C. Calculate the T_E (pipe wall thrust due to earth cover) as the higher value of the following two quantities:

- i. $\delta H_1 (S/2)$ where H_1 is the maximum height of cover above crown in ft (Figure 1)
- ii. $\delta H_1 R_t$

D. Calculate the $T_{(L+I)}$ (pipe wall thrust due to live load plus impact) as the higher value of the following two quantities:

- i. $\rho_{L+I} (S/2)$ k/ft
- ii. $\rho_{L+I} R_t$ k/ft

where ρ_{L+I} = pressure at the crown of pipe due to live load plus impact (k/ft^2)

- I = Live Load Impact Factor = 30% for $0'-0'' < H < 1'-0''$
 = 20% for $1'-1'' < H < 2'-0''$
 = 10% for $2'-1'' < H < 2'-11''$
 = 0% for $H > 3'-0''$

Figure 3 shows the distributed load area at the crown due to a single wheel load, distributed load areas for multiple axles, when there is no overlapping and when there is overlapping.

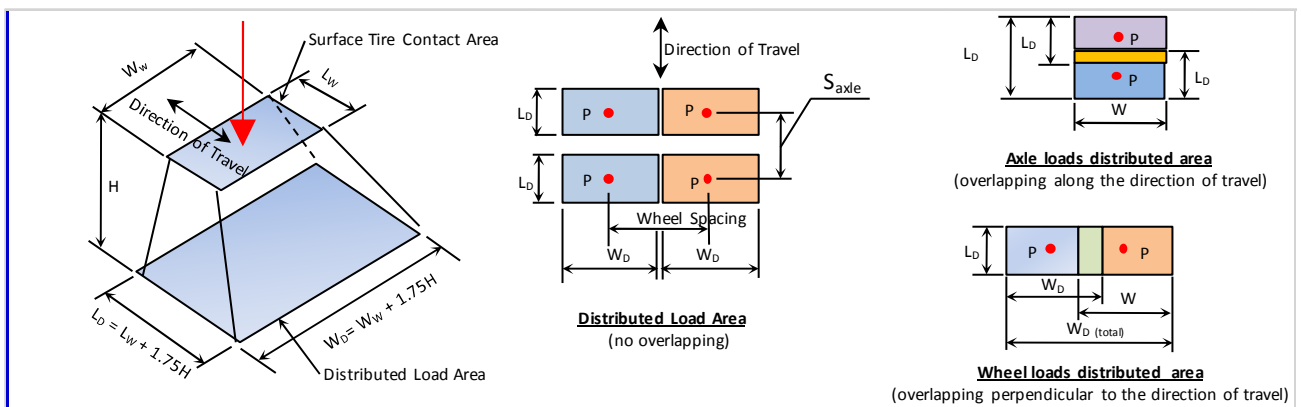

Figure 3 – Distributed Load Area for Single and Overlapped Loads

Calculate pressure on the culvert through the cover depth, with the following dimensions:

$$W_D = W_W + 1.75H$$

$$L_D = L_W + 1.75H$$

The surface tire contact area for all live loads:

$$W_W = 20'' = 1.67' \quad \text{hence } W_D = 1.67 + 1.75H \text{ ft}$$

$$L_W = 10'' = 0.83' \quad \text{hence } L_D = 0.83 + 1.75H \text{ ft}$$

7. Find Load Rating Factors for Ring Compression Structure:

A. Operating Load Rating Factor (RF_o) as the smaller of the following two values:

i. RF_o based on wall strength

$$RF_{o-w} = (T_{cap} - 1.95T_E) / 1.3T_{(L+I)}$$

ii. RF_o based on minimum cover requirements

$$RF_{o-c} = H_2^2 / C(h)^2 \quad \text{where } C = 2.36 H_2 / S + 0.528 \leq 1.00$$

where h = minimum cover requirements over the crown, ft

(AASHTO Sections 12.4.1.5, 12.5.3.3, 12.6.1.5 or 12.7.2.1)

B. Inventory Load Rating Factor (RF_i) as the smaller of the following two values:

i. RF_i based on wall strength

$$RF_{i-w} = 3/5 RF_{o-w}$$

ii. RF_i based on minimum cover requirements

$$RF_{i-c} = H_2^2 / (h)^2$$

Part B Guidance

Use the Existing Bridge Plans and/or Field Measurements to find the following Structural Dimensions:

1. Find the following structural dimensions as shown in Figure 4:

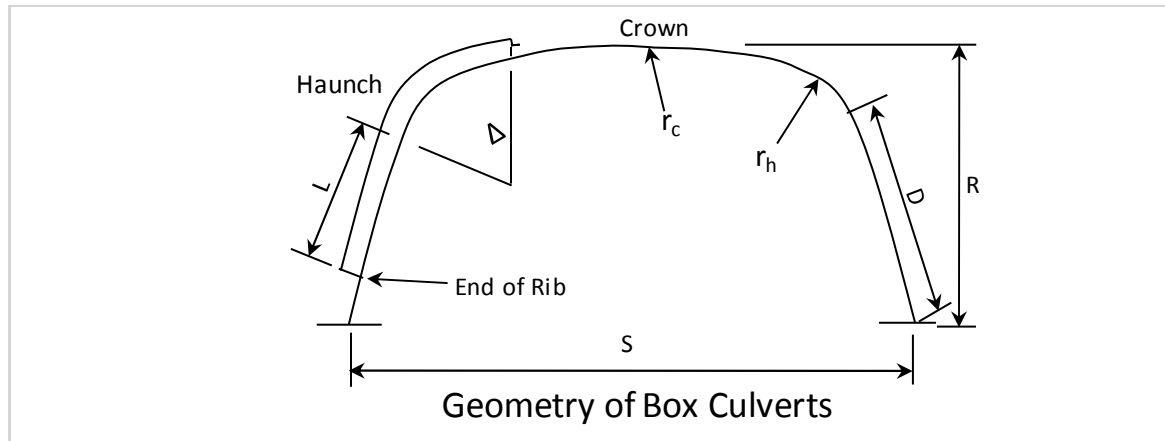

Figure 4 – Structural Plate Box Culverts

S = Span Length in ft (8'-9" to 25'-5")

R = Rise in ft (2'-6" to 10'-6")

r_c = Radius of crown in ft (See Figure 4), (<24'-9-1/2")

r_h = Radius of haunch in ft (See Figure 4), (>2'-6")

Δ = Haunch radius included angle (50° to 70°)

D = Length of leg (measured to bottom of the plate, may vary from 4-3/4" to 71")

L = Minimum length of rib on leg in ft (least of 19", (D-3.0)", or to within 3.0" of the top

of a concrete footing)

H = Height of cover from the box culvert rise to top of pavement, ft

γ_s = Soil density (k/ft³) = 0.120 k/ ft³

2. Compare the actual field measurements with the geometric requirements listed as above. The guidance presented below cannot be used if the geometric requirements are not met. In that case, special analysis may be required.

3. Calculate the Box Culvert Moment Capacities at Crown ($M_{cap (Crown)}$) in k-ft/ft in the longitudinal direction of culvert and at Haunch ($M_{cap (Haunch)}$) in k-ft/ft in the longitudinal direction of culvert as follows:

Calculate $M_{cap (Crown)}$ as the moment capacity of the crown, M_p adjusted for condition factors as shown in the appropriate table in Appendix III for Steel Box Culverts.

Calculate $M_{cap (Haunch)}$ as the moment capacity of the haunch M_p adjusted for condition factors as shown in the appropriate table in Appendix III for Steel Box Culverts.

For Aluminum Box Culverts manufactured by CONTECH, see Appendix IV for M_p values.

For Aluminum Box Culverts manufactured by other manufacturer, please contact the manufacturer for M_p values. If the manufacturer cannot be contacted or M_p values cannot be obtained, the load rating may be performed through the use of engineering judgement as per NJDOT's guidelines for "Load Capacity Ratings through Engineering Judgement".

4. Calculate the Box Culvert Dead Load Moment by the following formula:

$$M_{DL} = \gamma_s \{S^3 [0.0053 - 0.00024(S - 12)] + 0.053 (H - 1.4) S^2\}$$

Where

M_{DL} = The sum of the nominal crown and haunch dead load moments (kip-ft/ft)

$$\text{Crown Moment due to Dead Load, } M_{E (crown)} = P_c C_H (M_{DL}) \quad (\text{kip-ft/ft})$$

$$\text{Haunch Moment due to Dead Load, } M_{E (haunch)} = (1.0 - P_c) C_H (M_{DL}) \quad (\text{kip-ft/ft})$$

Where,

P_c = Allowable range of the ratio of total moment carried by the crown
(See Appendix V how to find proper value for P_c)

C_H = Moment increase factor due to crown deflection

= 1.0 for Crown deflection (reduction in rise) less than 1% of span

= $1.15 - (H-1.4)/14$ for Crown deflection) of 1 to 3% of span

= Special analysis is required for Crown deflection greater than 3% of

span

5. Calculate the Box Culvert Live Load Moment by the following formula:

$$M_{LL} = C_{II} K_1 S / K_2 = 0.08/(H/S)^{0.2}, \text{ for } 8 < S < 20, \quad (\text{kip-ft/ft})$$

Where

M_{LL} = The sum of the nominal crown and haunch live load moments (kip-ft/ft)

C_{II} = Live load adjustment coefficient for axle loads, tandem axles, and axles with other

than 4 wheels

$$C_{II} = C_1 C_2 AL$$

AL = Total axle load on single axle or tandem axles in kips

C_1 = Adjustment coefficient for number of axles

$C_1 = 1.0$, for single axle;

$C_1 = (0.5 + S/50)$, for tandem axles, ($C_1 < 1.0$);

C_2 = Adjustment coefficient for number of wheels per axle. (Values for C_2 are given in

Appendix V)

$$K_1 = 0.08/(H/S)^{0.2}, \text{ for } 8 < S < 20,$$

$$K_1 = (0.08 - 0.002(S - 20)) / (H/S)^{0.2}, \text{ for } 20 < S < 26,$$

$$K_2 = 0.54H^2 - 0.4H + 5.05, \text{ for } 1.4 < H < 3.0,$$

$$K_2 = 1.90H + 3, \text{ for } 3.0 < S < 5.0,$$

6. Calculate the Box Culvert Live Load Moment at Crown and at Haunch by the following formula:

$$\text{Crown Moment due to Live Load, } M_{LL(\text{crown})} = P_c C_H (M_{LL}) \quad (\text{kip-ft/ft})$$

$$\text{Haunch Moment due to Live Load, } M_{LL(\text{haunch})} = (1.0 - P_c) C_H R_H (M_{LL}) \quad (\text{kip-ft/ft})$$

Where,

P_c = Allowable range of the ratio of total moment carried by the crown
(See Appendix V how to find proper value for P_c)

R_H = Haunch moment reduction factor
= (See Appendix V how to find proper value for R_H)

7. Find Load Rating Factors for Box Culverts:

- a. Operating Load Rating Factor (RF_o)

At the crown

$$RF_{o(\text{Crown})} = (M_{\text{cap}(\text{Crown})} - 1.5 M_{E(\text{crown})}) / 1.3 M_{LL(\text{crown})}$$

At the haunch

$$RF_{o(\text{Haunch})} = (M_{\text{cap}(\text{Haunch})} - 1.5 M_{E(\text{haunch})}) / 1.3 M_{LL(\text{haunch})}$$

The lower among the above two values is the operating load Rating Factor (RF_o) for the culvert.

b. Inventory Load Rating Factor (RF_i) is given by:

$$RF_i = 3/5 RF_o$$

Appendices

Appendix I

Section 12

SOIL-CORRUGATED METAL STRUCTURE INTERACTION SYSTEMS

12.1 GENERAL

12.1.1 Scope

The specifications of this Section are intended for the structural design of corrugated metal structures. It must be recognized that a buried flexible structure is a composite structure made up of the metal ring and the soil envelope, and that both materials play a vital part in the structural design of flexible metal structures.

Only Article 12.7 is applicable to structural plate box culverts.

12.1.2 Notations

- A = required wall area (Article 12.2.1)
A = area of pipe wall (Article 12.3.1)
AL = total axle load on single axle or tandem axles (Articles 12.8.4.3.2 and 12.8.4.4)
 C_1 = number of axles coefficient (Article 12.8.4.3.2)
 C_2 = number of wheels per axle coefficient (Article 12.8.4.3.2)
 C_{di} = dead load adjustment coefficient (Article 12.8.4.3.2)
 C_{li} = live load adjustment coefficient (Article 12.8.4.3.2)
D = straight leg of haunch (Article 12.8.2)
 E_m = modulus of elasticity of metal (Articles 12.2.2 and 12.3.2)
 E_m = modulus of elasticity of pipe material (Articles 12.2.4 and 12.3.4)
FF = flexibility factor (Articles 12.2.4 and 12.3.4)
 f_a = allowable stress—specified minimum yield point divided by safety factor (Article 12.2.1)
 f_{cr} = critical buckling stress (Articles 12.2.2 and 12.3.2)
 f_u = specified minimum tensile strength (Articles 12.2.2 and 12.3.2)
 f_y = specified minimum yield point (Article 12.3.1)
H = height of cover above crown (Article 12.8.4.4)
I = moment of inertia, per unit length, of cross section of the pipe wall (Articles 12.2.4 and 12.3.4)
k = soil stiffness factor (Articles 12.2.2 and 12.3.2)
 M_{dl} = dead load factored moment (Article 12.8.4.3.3)
 M_{ll} = live load factored moment (Article 12.8.4.3.3)
 M_{pc} = crown plastic moment capacity (Article 12.8.4.3.3)
 M_{ph} = haunch plastic moment capacity (Article 12.8.4.3.3)
P = design load (Article 12.1.4)
P = proportion of total moment carried by the crown. Limits for P are given in Table 12.7.4D (Article 12.8.4.3.3)
r = radius of gyration of corrugation (Articles 12.2.2 and 12.3.2)
 r_c = radius of crown (Table 12.8.2A)
 r_h = radius of haunch (Table 12.8.2A)
R = rise of box culvert (Articles 12.7.2 and 12.8.4.4)
 R_n = haunch moment reduction factor (Article 12.8.4.3.3)
S = diameter of span (Articles 12.1.4, 12.2.2, 12.8.2, and 12.8.4.4)
 ν = pipe diameter or span (Articles 12.2.4, 12.3.2, and 12.3.4)
SF = safety factor (Article 12.2.3)
SS = required seam strength (Articles 12.2.3 and 12.3.3)
T = thrust (Article 12.1.4)
 T_L = thrust, load factor (Articles 12.3.1 and 12.3.3)
T, = thrust, service load (Articles 12.2.1 and 12.2.3)
t = length of stiffening rib on leg (Article 12.8.2)
V = reaction acting in leg direction (Article 12.8.4.4)
 Δ = haunch radius included angle (Table 12.8.2A)
 γ = unit weight of backfill (Articles 12.8.4.3.2 and 12.8.4.4)
 ϕ = capacity modification factor (Articles 12.3.1 and 12.3.3)

12.1.3 Loads

Design load, P, shall be the pressure acting on the structure. For earth pressures, see Article 3.20. For live load, see Articles 3.4 to 3.7, 3.11, 3.12, and 6.4, except that the

words "When the depth of fill is 2 feet or more" in Article 6.4.1 need not be considered. For loading combinations, see Article 3.22.

12.1.4 Design

12.1.4.1 The thrust in the wall shall be checked by three criteria. Each considers the mutual function of the metal wall and the soil envelope surrounding it. The criteria are:

- (a) Wall area;
- (b) Buckling stress;
- (c) Seam strength (structures with longitudinal seams).

12.1.4.2 The thrust in the wall is:

$$T = P \times \frac{S}{2} \quad (12-1)$$

where:

- P = design load, in pounds per square foot;
 S = diameter or span, in feet;
 T = thrust, in pounds per foot.

12.1.4.3 Handling and installation strength shall be sufficient to withstand impact forces when shipping and placing the pipe.

12.1.5 Materials

The materials shall conform to the AASHTO specifications referenced herein.

12.1.6 Soil Design

12.1.6.1 Soil Parameters

The performance of a flexible culvert is dependent on soil structure interaction and soil stiffness.

The following must be considered:

(a) Soils:

- (1) The type and anticipated behavior of the foundation soil must be considered; i.e., stability for bedding and settlement under load.
- (2) The type, compacted density, and strength properties of the soil envelope immediately adjacent to the pipe must be established. Good side fill is obtained from a granular material with little or no plasticity and free of organic material, i.e., AASHTO classification groups A-1, A-2, and A-3, compacted to a minimum 90% of standard density based on AASHTO Specification T 99 (ASTM D 698).

- (3) The density of the embankment material above the pipe must be determined. See Article 6.2.
- (b) Dimensions of soil envelope.

The general recommended criteria for lateral limits of the culvert soil envelope are as follows:

- (1) *Trench installations*—2-foot minimum each side of culvert. This recommended limit should be modified as necessary to account for variables such as poor in situ soils.
- (2) *Embankment installations*—one diameter or span each side of culvert.
- (3) The minimum upper limit of the soil envelope is 1 foot above the culvert.

12.1.6.2 Pipe Arch Design

The design of the corner backfill shall account for corner pressure which shall be considered to be approximately equal to thrust divided by the radius of the pipe arch corner. The soil envelope around the corners of pipe arches shall be capable of supporting this pressure.

12.1.6.3 Arch Design

12.1.6.3.1 Special design considerations may be applicable; a buried flexible structure may raise two important considerations. The first is that it is undesirable to make the metal arch relatively unyielding or fixed compared with the adjacent sidefill. The use of massive footings or piles to prevent any settlement of the arch is generally not recommended.

Where poor materials are encountered, consideration should be given to removing some or all of this poor material and replacing it with acceptable material.

The footing should be designed to provide uniform longitudinal settlement, of acceptable magnitude from a functional aspect. Providing for the arch to settle will protect it from possible drag down forces caused by the consolidation of the adjacent sidefill.

The second consideration is bearing pressure of soils under footings. Recognition must be given to the effect of depth of the base of footing and the direction of the footing reaction from the arch.

Footing reactions for the metal arch are considered to act tangential to the metal plate at its point of connection to the footing. The value of the reaction is the thrust in the metal arch plate at the footing.

12.1.6.3.2 Invert slabs and other appropriate measures shall be provided to anticipate scour.

12.1.7 Abrasive or Corrosive Conditions

Extra metal thickness, or coatings, may be required for resistance to corrosion and abrasion. For highly abrasive conditions, a special design may be required.

12.1.8 Minimum Spacing

When multiple lines of pipes or pipe arches greater than 48 inches in diameter or span are used, they shall be spaced so that the sides of the pipe shall be no closer than one-half diameter or 3 feet, whichever is less, to permit adequate compaction of backfill material. For diameters up to and including 48 inches, the minimum clear spacing shall not be less than 2 feet.

12.1.9 End Treatment

Protection of end slopes may require special consideration where backwater conditions may occur, or where erosion and uplift could be a problem. Culvert ends constitute a major run-off-the-road hazard if not properly designed. Safety treatment, such as structurally adequate grating that conforms to the embankment slope, extension of culvert length beyond the point of hazard, or provision of guardrail, are among the alternatives to be considered. End walls on skewed alignment require a special design.

12.1.10 Construction and Installation

The construction and installation shall conform to Section 23—Division II.

12.2 SERVICE LOAD DESIGN

Service Load Design is a working stress method, as traditionally used for culvert design.

12.2.1 Wall Area

$$A = T_s/f_a \quad (12-2)$$

where:

- A = required wall area in square inches per foot;
- T_s = thrust, service load in pounds per foot;
- f_a = allowable stress—specified minimum yield point, pounds per square inch, divided by safety factor, f_u/SF .

12.2.2 Buckling

Corrugations with the required wall area, A, shall be checked for possible buckling. If the allowable buckling stress, f_{cr}/SF , is less than f_a , the required area must be recalculated using f_{cr}/SF in lieu of f_a . Formulae for buckling are:

$$\text{If } S < \frac{r}{k} \sqrt{\frac{24E_m}{f_u}} \text{ then } f_{cr} = f_u - \frac{f_u^2}{48E_m} \left(\frac{kS}{r}\right)^2 \quad (12-3)$$

$$\text{If } S < \frac{r}{k} \sqrt{\frac{24E_m}{f_u}} \text{ then } f_{cr} = \frac{12E_m}{(kS/r)^2} \quad (12-4)$$

where:

- f_u = specified minimum tensile strength in pounds per square inch;
- f_{cr} = critical buckling stress in pounds per square inch;
- k = soil stiffness factor = 0.22;
- S = diameter or span in inches;
- r = radius of gyration of corrugation in inches;
- E_m = modulus of elasticity of metal in pounds per square inch.

12.2.3 Seam Strength

For pipe fabricated with longitudinal seams (riveted, spot-welded, bolted), the seam strength shall be sufficient to develop the thrust in the pipe wall.

The required seam strength shall be

$$SS = T_s(SF) \quad (12-5)$$

where:

- SS = required seam strength in pounds per foot;
- T_s = thrust in pipe wall in pounds per foot;
- SF = safety factor.

12.2.4 Handling and Installation Strength

Handling and installation rigidity is measured by a flexibility factor, FF, determined by the formula:

$$FF = s^2/E_m I \quad (12-6)$$

where:

- FF = flexibility factor in inches per pound;
- s = pipe diameter or maximum span in inches;
- E_m = modulus of elasticity of the pipe material in pounds per square inch;

I = moment of inertia per unit length of cross section of the pipe wall in inches to the 4th power per inch.

12.3 LOAD FACTOR DESIGN

Load Factor Design is an alternative method of design based on ultimate strength principles.

12.3.1 Wall Area

$$A = T_L / \phi f_y \quad (12-7)$$

where:

A = area of pipe wall in square inches per foot;
 T_L = thrust, load factor in pounds per foot;
 f_y = specified minimum yield point in pounds per square inch;
 ϕ = capacity modification factor.

12.3.2 Buckling

If f_{cr} is less than f_y , A must be recalculated using f_{cr} in lieu of f_y :

$$\text{If } s < \frac{r}{k} \sqrt{\frac{24E_m}{f_u}} \text{ then } f_{cr} = f_u - \frac{f_u^2}{48E_m} (ks/r)^2 \quad (12-8)$$

$$\text{If } s > \frac{r}{k} \sqrt{\frac{24E_m}{f_u}} \text{ then } f_{cr} = \frac{12E_m}{(ks/r)^2} \quad (12-9)$$

where:

f_u = specified minimum metal strength in pounds per square inch;
 f_{cr} = critical buckling stress in pounds per square inch;
 k = soil stiffness factor = 0.22;
 s = pipe diameter or span in inches;
 r = radius of gyration of corrugation in inches;
 E_m = modulus of elasticity of metal in pounds per square inch.

12.3.3 Seam Strength

For pipe fabricated with longitudinal seams (riveted, spot-welded, bolted), the seam strength shall be sufficient to develop the thrust in the pipe wall. The required seam strength shall be:

$$SS = T_L / \phi \quad (12-10)$$

where:

SS = required seam strength in pounds per foot;
 T_L = thrust multiplied by applicable factor, in pounds per linear foot;
 ϕ = capacity modification factor.

12.3.4 Handling and Installation Strength

Handling rigidity is measured by a flexibility factor, FF , determined by the formula:

$$FF = s^2 / E_m I \quad (12-11)$$

where:

FF = flexibility factor in inches per pound;
 s = pipe diameter or maximum span in inches;
 E_m = modulus of elasticity of the pipe material in pounds per square inch;
 I = moment of inertia per unit length of cross section of the pipe wall in inches to the 4th power per inch.

12.4 CORRUGATED METAL PIPE

12.4.1 General

12.4.1.1 Corrugated metal pipe and pipe-arches may be of riveted, welded, or lock seam fabrication with annular or helical corrugations. The specifications are:

Aluminum	Steel
AASHTO M 190, M 196	AASHTO M 36, M 190, M 245

12.4.1.2 Service Load Design—safety factor, SF

Seam strength	= 3.0
Wall area	= 2.0
Buckling	= 2.0

12.4.1.3 Load Factor Design—capacity modification factor, ϕ

For Helical pipe with lock seam or fully welded seam:

Wall area and buckling $\phi = 1.0$

For Annular pipe with spot welded, riveted or bolted seam:

Wall area and buckling $\phi = 1.0$
 Seam strength $\phi = 0.67$

12.4.1.4 Flexibility Factor

(a) For steel conduits, FF should generally not exceed the following values:

¼-in. and ½-in. depth corrugation,

$$FF = 4.3 \times 10^{-2}$$

1-in. depth corrugation, $FF = 3.3 \times 10^{-2}$

(b) For aluminum conduits, FF should generally not exceed the following values:

¼-in. and ½-in. depth corrugations,

$$FF = 3.1 \times 10^{-2} \text{ for } 0.060 \text{ in. material thickness}$$

$$FF = 6.1 \times 10^{-2} \text{ for } 0.075 \text{ in. material thickness}$$

$$FF = 9.2 \times 10^{-2} \text{ for all other material thicknesses}$$

1-in. depth corrugation, $FF = 6 \times 10^{-2}$

12.4.1.5 Minimum Cover

The minimum cover for design loads shall be Span/8 but not less than 12 inches. (The minimum cover shall be measured from the top of a rigid pavement or the bottom of a flexible pavement.) For construction requirements, see Article 23.10—Division II.

12.4.2 Seam Strength**Minimum Longitudinal Seam Strength**

2 × 1/2 and 2-2/3 × 1/2 Corrugated Steel Pipe—Riveted or Spot Welded				3 × 1 Corrugated Steel Pipe—Riveted or Spot Welded		
Thickness (in.)	Rivet Size (in.)	Single Rivets (kips/ft)	Double Rivets (kips/ft)	Thickness (in.)	Rivet Size (in.)	Double Rivets (kips/ft)
0.064	5/16	16.7	21.6	0.064	3/8	28.7
0.079	5/16	18.2	29.8	0.079	3/8	35.7
0.109	3/8	23.4	46.8	0.109	7/16	53.0
0.138	3/8	24.5	49.0	0.138	7/16	63.7
0.168	3/8	25.6	51.3	0.168	7/16	70.7

2 × 1/2 and 2-2/3 × 1/2 Corrugated Aluminum Pipe—Riveted

Thickness (in.)	Rivet Size (in.)	Single Rivets (kips/ft)	Double Rivets (kips/ft)
0.060	5/16	9.0	14.0
0.075	5/16	9.0	18.0
0.105	3/8	15.6	31.5
0.135	3/8	16.2	33.0
0.164	3/8	16.8	34.0

3 × 1 Corrugated Aluminum Pipe—Riveted			6 × 1 Corrugated Aluminum Pipe—Riveted		
Thickness (in.)	Rivet Size (in.)	Double Rivets (kips/ft)	Thickness (in.)	Rivet Size (in.)	Double Rivets (kips/ft)
0.060	3/8	16.5	0.060	1/2	16.0
0.075	3/8	20.5	0.075	1/2	19.9
0.105	1/2	28.0	0.105	1/2	27.9
0.135	1/2	42.0	0.135	1/2	35.9
0.164	1/2	54.5	0.167	1/2	43.5

12.4.3 Section Properties

12.4.3.1 Steel Conduits

Thickness (in.)	1-1/2 × 1/4 Corrugation			2-2/3 × 1/2 Corrugation		
	A _s (sq in./ft)	r (in.)	I × 10 ⁻³ (in. ⁴ /in.)	A _s (sq in./ft)	r (in.)	I × 10 ⁻³ (in. ⁴ /in.)
0.028	0.304					
0.034	0.380					
0.040	0.456	0.0816	0.253	0.465	0.1702	1.121
0.052	0.608	0.0824	0.344	0.619	0.1707	1.500
0.064	0.761	0.0832	0.439	0.775	0.1712	1.892
0.079	0.950	0.0846	0.567	0.968	0.1721	2.392
0.109	1.331	0.0879	0.857	1.356	0.1741	3.425
0.138	1.712	0.0919	1.205	1.744	0.1766	4.533
0.168	2.098	0.0967	1.635	2.133	0.1795	5.725

Thickness (in.)	3 × 1 Corrugation			5 × 1 Corrugation		
	A _s (sq in./ft)	r (in.)	I × 10 ⁻³ (in. ⁴ /in.)	A _s (sq in./ft)	r (in.)	I × 10 ⁻³ (in. ⁴ /in.)
0.064	0.890	0.3417	8.659	0.794	0.3657	8.850
0.079	1.113	0.3427	10.883	0.992	0.3663	11.092
0.109	1.560	0.3448	15.459	1.390	0.3677	15.650
0.138	2.008	0.3472	20.183	1.788	0.3693	20.317
0.168	2.458	0.3499	25.091	2.186	0.3711	25.092

12.4.3.2 Aluminum Conduits

Thickness (in.)	1-1/2 × 1/4 Corrugation			2-2/3 × 1/2 Corrugation		
	A _s (sq in./ft)	r (in.)	I × 10 ⁻³ (in. ⁴ /in.)	A _s (sq in./ft)	r (in.)	I × 10 ⁻³ (in. ⁴ /in.)
0.048	0.608	0.0824	0.344			
0.060	0.761	0.0832	0.349	0.775	0.1712	1.892
0.075				0.968	0.1721	2.392
0.105				1.356	0.1741	3.425
0.135				1.745	0.1766	4.533
0.164				2.130	0.1795	5.725

Thickness (in.)	3 × 1 Corrugation			6 × 1		
	A _s (sq in./ft)	r (in.)	I × 10 ⁻³ (in. ⁴ /in.)	Effective Area (sq in./ft)	r (in.)	I × 10 ⁻³ (in. ⁴ /in.)
0.060	0.890	0.3417	8.659	0.775	0.387	8.505
0.075	1.118	0.3427	10.883	0.968	0.484	10.631
0.105	1.560	0.3448	15.459	1.356	0.678	14.340
0.135	2.088	0.3472	20.183	1.744	0.872	19.319
0.164	2.458	0.3499	25.091	2.133	1.066	23.760

12.4.4 Chemical and Mechanical Requirements

12.4.4.1 Aluminum-corrugated metal pipe and pipe-arch material requirements—AASHTO M 197

Mechanical Properties for Design			
Material Grade	Minimum Tensile Strength (psi)	Minimum Yield Point (psi)	Mod. of Elast. (psi)
3004-H34	31,000	24,000	10×10^6
3004-H32	27,000	20,000	10×10^6

H34 temper must be used with riveted pipes to achieve seam strength. Both H32 and H34 temper material may be used with helical pipe.

12.4.4.2 Steel-corrugated metal pipe and pipe-arch material requirements—AASHTO M 218

M 246:

Mechanical Properties for Design		
Minimum Tensile Strength (psi)	Minimum Yield Point (psi)	Mod. of Elast. (psi)
45,000	33,000	29×10^6

12.4.5 Smooth-Lined Pipe

Corrugated metal pipe composed of a smooth liner and corrugated shell attached integrally at helical seams spaced not more than 30 inches apart may be designed in accordance with Article 12.1 on the same basis as a standard corrugated metal pipe having the same corrugations as the shell and a weight per foot equal to the sum of the weights per foot of liner and helically corrugated shell. The shell shall be limited to corrugations having a maximum pitch of 3 inches and a thickness of not less than 60% of the total thickness of the equivalent standard pipe.

12.5 SPIRAL RIB METAL PIPE

12.5.1 General

12.5.1.1 Spiral Rib metal pipe and pipe-arches are helically formed from a single thickness of steel or aluminum with outwardly projecting ribs and a lockseam. The specifications are

Aluminum: AASHTO M 196, M 190
Steel: AASHTO M 36, M 245, M 190

12.5.2 Soil Design

12.5.2.1 Spiral Rib pipe and pipe-arches installed in embankment conditions shall have a granular soil backfill envelope extending to a minimum of one span on each side of the pipe and one foot above the pipe. This granular soil envelope shall meet the material and compaction requirements of Article 12.1.6.1 (a).

12.5.2.2 Spiral Rib pipe and pipe-arches installed in standard trench conditions shall have a backfill envelope that

- (a) Meets the material and compaction requirements of Article 12.1.6.1 (a).
- (b) Extends a minimum of 2 feet each side of the pipe to the trench wall. To account for variable conditions, this recommendation shall be increased as required for poor in situ soils. It may be decreased for trenches in rock or high-bearing strength in situ soils to the limits required for backfill compaction. In this condition, the use of cementitious grouts allows the envelope to be decreased to 2 inches, each side of the pipe.
- (c) Extends a minimum of 1 foot above the crown of the pipe.

12.5.2.3 Pipe-Arch Design

The design of the corner backfill shall meet the requirements of Article 12.1.6.2.

12.5.2.4 Special Conditions

Design and installation shall meet the requirements of Article 12.1.7 for abrasive or corrosive conditions; Article 12.1.8 for minimum spacing of multiple runs; and Article 12.1.9 for end treatment.

12.5.2.5 Construction and Installation

Construction and installation shall conform to Section 23—Division II.

12.5.3 Design

12.5.3.1 Service load design shall conform to the requirements of Article 12.2—Safety Factor (SF) shall be:

Wall Area = 2.0
Buckling = 2.0

12.5.3.1 Load factor design shall conform to the requirements of Article 12.3—Capacity modification factor, ϕ , shall be

$\phi = 1.00$

12.5.3.2 Flexibility Factor

(a) For steel conduits, FF should generally not exceed the following values

(1) For installation conforming to Article 12.5.2.1

$$FF = 0.217 I^{0.33} \text{ for } \frac{3}{4} \times \frac{3}{4} \times 7\frac{1}{2} \text{ configurations.}$$

$$FF = 0.140 I^{0.33} \text{ for } \frac{3}{4} \times 1 \times 11\frac{1}{2} \text{ configurations.}$$

(2) For installations conforming to Article 12.5.2.2

$$FF = 0.263 I^{0.33} \text{ for } \frac{3}{4} \times \frac{3}{4} \times 7\frac{1}{2} \text{ configurations}$$

$$FF = 0.163 I^{0.33} \text{ for } \frac{3}{4} \times 1 \times 11\frac{1}{2} \text{ configurations.}$$

Note: 1 is the applicable moment of inertia value from Article 12.5.4.1.

(b) For aluminum conduits, FF should generally not exceed the following values

(1) For installations conforming to Article 12.5.2.1

$$FF = 0.340 I^{0.33} \text{ for } \frac{3}{4} \times \frac{3}{4} \times 7\frac{1}{2} \text{ configurations.}$$

$$FF = 0.175 I^{0.33} \text{ for } \frac{3}{4} \times 1 \times 11\frac{1}{2} \text{ configurations.}$$

(2) For installations conforming to Article 12.5.2.2

$$FF = 0.420 I^{0.33} \text{ for } \frac{3}{4} \times \frac{3}{4} \times 7\frac{1}{2} \text{ configurations.}$$

$$FF = 0.215 I^{0.33} \text{ for } \frac{3}{4} \times 1 \times 11\frac{1}{2} \text{ configurations.}$$

Note: 1 is the applicable moment of inertia value from Article 12.5.4.2.

12.5.3.3 Minimum Cover

The minimum cover for design loads shall be measured from the top of rigid pavement or the bottom of flexible pavement such that

(a) For steel conduits the minimum cover shall be span/4, but not less than 12 inches;

(b) For aluminum conduits with spans of 48 inches or less, the minimum cover shall be span/2, but not less than 12 inches. For aluminum conduits with spans greater than 48 inches, the minimum cover shall be span/2.75, but not less than 24 inches.

For construction requirements, see Article 26.6—Division II.

12.5.4 Section Properties

12.5.4.1 Steel Conduits

Thickness (in.)	$\frac{3}{4} \times \frac{3}{4} \times 7\frac{1}{2}$ Configuration		
	A_s (sq in./ft)	r (in.)	$I \times 10^{-3}$ (in. ⁴ /in.)
0.064	0.509	0.258	2.821
0.079	0.712	0.250	3.701
0.109	1.184	0.237	5.537
0.138	1.717	0.228	7.433

Thickness (in.)	$\frac{3}{4} \times 1 \times 11\frac{1}{2}$ Configuration		
	A_s (sq in./ft)	r (in.)	$I \times 10^{-3}$ (in. ⁴ /in.)
0.374	0.383	4.580	
0.524	0.373	6.080	
0.883	0.355	9.260	

Note: Effective section properties at full yield stress.

12.5.4.2 Aluminum Conduits

Thickness (in.)	$\frac{3}{4} \times \frac{3}{4} \times 7\frac{1}{2}$ Configuration		
	A_s (sq in./ft)	r (in.)	$I \times 10^{-3}$ (in. ⁴ /in.)
0.060	0.415	0.272	2.558
0.075	0.569	0.267	3.372
0.105	0.914	0.258	5.073
0.135	1.290	0.252	6.826

Thickness (in.)	$\frac{3}{4} \times 1 \times 11\frac{1}{2}$ Configuration		
	A_s (sq in./ft)	r (in.)	$I \times 10^{-3}$ (in. ⁴ /in.)
0.312	0.396	4.080	
0.427	0.391	5.450	
0.697	0.380	8.390	
1.009	0.369	11.480	

Note: Effective section properties at full yield stress.

12.5.5 Chemical and Mechanical Requirements

12.5.5.1 Steel Spiral Rib Pipe and Pipe-Arch Requirements—AASHTO M 218

Mechanical Properties for Design

Minimum Tensile Strength (psi)	Minimum Yield Point (psi)	Modulus of Elasticity (psi)
45,000	33,000	29×10^6

12.5.5.2 Aluminum Spiral Rib Pipe and Pipe-Arch Requirements—AASHTO M 197

Mechanical Properties for Design

Material Grade	Minimum Tensile Strength (psi)	Minimum Yield Point (psi)	Mod. of Elast. (psi)
3004-H34	31,000	24,000	10×10^6
3004-H32	27,000	20,000	10×10^6

H34 temper must be used with riveted pipes to achieve seam strength. Both H32 and H34 temper material may be used with helical pipe.

12.6 STRUCTURAL PLATE PIPE STRUCTURES

12.6.1 General

12.6.1.1 Structural plate pipe, pipe-arches, and arches shall be bolted with annular corrugations only.

The specifications are

Aluminum	Steel
AASHTO M 219	AASHTO M 167

12.6.1.2 Service Load Design—safety factor, SF

Seam strength = 3.0

Wall area = 2.0

Buckling = 2.0

12.6.1.3 Load Factor Design—Capacity Modification Factor, ϕ

Wall area and buckling $\phi = 1.0$

Seam strength $\phi = 0.67$

12.6.1.4 Flexibility Factor

(a) For steel conduits, FF should generally not exceed the following values

6 in. \times 2 in. corrugation FF = 2.0×10^{-2} (pipe)

6 in. \times 2 in. corrugation FF = 3.0×10^{-2} (pipe-arch)

6 in. \times 2 in. corrugation FF = 3.0×10^{-2} (arch)

(b) For aluminum conduits, FF should generally not exceed the following values

9 in. \times 2½ in. corrugation FF = 2.5×10^{-2} (pipe)

9 in. \times 2½ in. corrugation FF = 3.6×10^{-2} (pipe-arch)

9 in. \times 2½ in. corrugation FF = 3.6×10^{-2} (arch)

12.6.1.5 Minimum Cover

The minimum cover for design loads shall be Span/8 but not less than 12 inches. (The minimum cover shall be measured from the top of a rigid pavement or the bottom of a flexible pavement.) For construction requirements, see Article 26.6—Division II.

12.6.2 Seam Strength

Minimum Longitudinal Seam Strengths

Thickness (in.)	6" \times 2" Steel Structural Plate Pipe			
	Diameter (in.)	4 Bolts/ft (kips/ft)	6 Bolts/ft (kips/ft)	8 Bolts/ft (kips/ft)
0.109	¾	43.0		
0.138	¾	62.0		
0.168	¾	81.0		
0.188	¾	93.0		
0.218	¾	112.0		
0.249	¾	132.0		
0.280	¾	144.0	180	194
0.318	7/8			235
0.380	7/8			285

9" \times 2½" Aluminum Structural Plate Pipe

Thickness (in.)	Bolt Size (in.)	Steel Bolts	Aluminum Bolts
		5½ Bolts Per ft (kips/ft)	5½ Bolts Per ft (kips/ft)
0.100	¾	28.0	26.4
0.125	¾	41.0	34.8
0.150	¾	54.1	44.4
0.15	¾	63.7	52.8
0.200	¾	73.4	52.8
0.225	¾	83.2	52.8
0.250	¾	93.1	52.8

12.6.3 Section Properties

12.6.3.1 Steel Conduits

Thickness (in.)	6" \times 2" Corrugations		
	A_s (in ² /ft)	r (in.)	$I \times 10^{-3}$ (in. ⁴ /in.)
0.109	1.556	0.682	60.411
0.138	2.003	0.684	78.175
0.168	2.449	0.686	96.163
0.188	2.739	0.688	108.000
0.218	3.199	0.690	126.922
0.249	3.650	0.692	146.172
0.280	4.119	0.695	165.836
0.318	4.671	0.698	190.000
0.380	5.613	0.704	232.000

12.6.3.2 Aluminum Conduits

Thickness (in.)	9" \times 2½" Corrugations		
	A_s (sq in./ft)	r (in.)	$I \times 10^{-3}$ (in. ⁴ /in.)
0.100	1.404	0.8438	83.065
0.125	1.750	0.8444	103.991
0.150	2.100	0.8449	124.883
0.175	2.449	0.8454	145.895
0.200	2.799	0.8460	166.959
0.225	3.149	0.8468	188.179
0.250	3.501	0.8473	209.434

12.6.4 Chemical and Mechanical Properties

12.6.4.1 Aluminum Structural Plate Pipe, Pipe-Arch, and Arch Material Requirements—AASHTO M 219, Alloy 5052

Mechanical Properties for Design

Thickness (in.)	Minimum Tensile Strength (psi)	Minimum Yield Point (psi)	Mod. of Elast. (psi)
0.100 to 0.175	35,000	24,000	10×10^6
0.176 to 0.250	34,000	24,000	10×10^6

12.6.4.2 Steel Structural Plate Pipe, Pipe-Arch, and Arch Material Requirements—AASHTO M 167

Mechanical Properties for Design

Minimum Tensile Strength (psi)	Minimum Yield Point (psi)	Mod. of Elast. (psi)
45,000	33,000	29×10^6

12.6.5 Structural Plate Arches

The design of structural plate arches should be based on ratios of a rise to span of 0.3 minimum.

12.7 LONG-SPAN STRUCTURAL PLATE STRUCTURES

12.7.1 General

Long-span structural plate structures are short-span bridges defined as follows:

12.7.1.1 Structural plate structures (pipe, pipe-arch, and arch) that exceed the maximum sizes imposed by Article 12.6.

12.7.1.2 Special shapes of any size that involve a relatively large radius of curvature in crown or side plates. Vertical ellipses, horizontal ellipses, underpasses, low profile arches, high profile arches, and inverted pear shapes are the terms describing these special shapes.

12.7.1.3 Wall strength and chemical and mechanical properties shall be in accordance with Article 12.6. The

construction and installation shall conform to Section 26—Division II.

12.7.2 Structure Design

12.7.2.1 General

Long-span structures shall be designed in accordance with Articles 12.1 and 12.6, and 12.2 or 12.3 except that the requirements for buckling and flexibility factor shall not apply. The span in the formulae for thrust shall be replaced by twice the top arc radius. Long-span structures shall include acceptable special features. Minimum requirements are detailed in Table 12.7.2A.

TABLE 12.7.2A Minimum Requirements for Long-Span Structures with Acceptable Special Features

I. TOP ARC MINIMUM THICKNESS

	Top Radius (ft)				
	15	15-17	17-20	20-23	23-25
6" × 2" Corrugated Steel Plates	0.109 in.	0.138 in.	0.168 in.	0.218 in.	0.249 in.

II. MINIMUM COVER IN FEET

Steel Thickness ^a in inches	TOP RADIUS (FT)				
	15	15-17	17-20	20-23	23-25
.109	2.5				
.138	2.5	3.0			
.168	2.5	3.0	3.0		
.188	2.5	3.0	3.0		
.218	2.0	2.5	2.5	3.0	
.249	2.0	2.0	2.5	3.0	4.0
.280	2.0	2.0	2.5	3.0	4.0

III. GEOMETRIC LIMITS

- Maximum Plate Radius—25 Ft.
- Maximum Central Angle of Top Arc = 80°
- Minimum Ratio, Top Arc Radius to Side Arc Radius = 2
- Maximum Ratio, Top Arc Radius to Side Arc Radius = 5*

*Note: Sharp radii generate high soil bearing pressures. Avoid high ratios when significant heights of fill are involved.

IV. SPECIAL DESIGNS

Structures not described herein shall be regarded as special designs.

*When reinforcing ribs are used the moment of inertia of the composite section shall be equal to or greater than the moment of inertia of the minimum plate thickness shown.

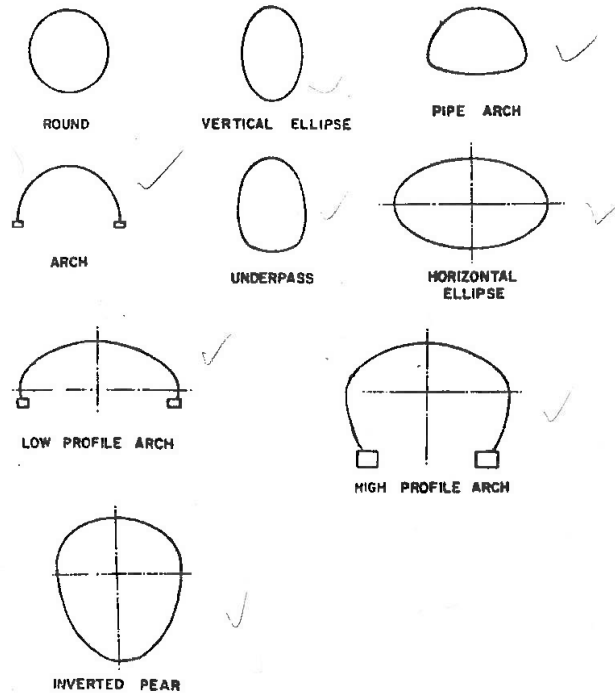

FIGURE 12.7.1A Standard Terminology of Structural Plate Shapes Including Long-Span Structures

12.7.2.2 Acceptable Special Features

- (a) Continuous longitudinal structural stiffeners connected to the corrugated plates at each side of the top arc. Stiffeners may be metal or reinforced concrete either singly or in combination.
- (b) Reinforcing ribs formed from structural shapes curved to conform to the curvature of the plates, fastened to the structure as required to ensure integral action with the corrugated plates, and spaced at such intervals as necessary to increase the moment of inertia of the section to that required by the design.

12.7.3 Foundation Design

12.7.3.1 Settlement Limits

Foundation design requires a geotechnical survey of the site to ensure that both the structure and the critical backfill zone on each side of the structure will be

properly supported, within the following limits and considerations:

- (1) Once the structure has been backfilled over the crown, settlements of the supporting backfill relative to the structure must be limited to control dragdown forces. If the sidefill will settle more than the structure, a detailed analysis may be required.
- (2) Settlements along the longitudinal centerline of arch structures must be limited to maintain slope and preclude footing cracks (arches). Where the structure will settle uniformly with the adjacent soils, long spans with full inverts can be built on a camber to achieve a proper final grade.
- (3) Differential settlements across the structure (from springline to springline) shall not exceed $0.01 (\text{Span})^2/\text{rise}$ in order to limit excessive rotation of the structure. More restrictive settlement limits may be required to protect pavements, or to limit longitudinal differential deflections.

12.7.3.2 Footing Reactions (Arch Structures)

Footing reactions are calculated by simple statics to support the vertical loads. Soil load footing reactions (V_{DL}) are taken as the weight of the fill and pavement above the springline of the structure.

Live loads, which provide relatively limited pressure zones acting on the crown of the structure are distributed to the footings.

Footing reactions may be taken as

$$R_V = (V_{DL} + V_{LL}) \cos \Delta \quad (12.7.3.2-1)$$

$$R_H = (V_{DL} + V_{LL}) \sin \Delta \quad (12.7.3.2-2)$$

where

R_V = Vertical footing reaction component (K/ft)

R_H = Horizontal reaction component (K/ft)

V_{DL} = $[H_2(S) - A_T] \alpha/2$

V_{LL} = $n(AL)/(L_w + 2H_1)$

Δ = Return angle of the structure (degrees)

AL = Axle load (K) - 50% of all axles that can be placed on the structure at one time

32K for H 20/HS 20

40K for H 25/HS 25

50K for Tandem Axle

160K for E80 Railroad Loading

A_T = the area of the top portion of the structure above the springline (ft.²)

H_1 = Height of cover above the footing to traffic surface (ft.)

H_2 = Height of cover from the structure's springline to traffic surface (ft.)

L_w = Lane width (ft.)

n = integer $\left[\frac{2H_1}{L_w} + 2 \right] \leq$ number of traffic lanes

a = Unit weight of soil (k/ft³)

12.7.3.3 Footing Design

Reinforced concrete footings shall be designed in accordance with Article 4.4 to limit settlements to the requirements of Article 12.7.3.1.

Footings should be sized to provide bearing pressures equal to or greater than those exerted by the structural backfill on the foundation. This helps to ensure that if settlements do occur the footings and backfill will settle in approximately equal amounts avoiding excessive drag-down loads on the structure.

12.7.4 Soil Envelope Design

Structural backfill material in the envelope around the structure shall meet the requirements of Article 12.7.4.1.

The width of the envelope, on each side of the structure shall be sized to limit shape change during construction activities outside the envelope and to control deflections under service loads. (See Articles 12.7.4.2 and 12.7.4.3).

12.7.4.1 Soil Requirements

Granular type soils shall be used as structure backfill (the envelope next to the metal structure). The order of preference of acceptable structure backfill materials is as follows:

(a) Well-graded sand and gravel; sharp, rough, or angular if possible.

(b) Uniform sand or gravel.

(c) Approved stabilized soil shall be used only under direct supervision of a competent, experienced soils Engineer. Plastic soils shall not be used.

The structure backfill material shall conform to one of the following soil classifications from AASHTO M 145, Table 2: for height of fill less than 12 feet, A-1, A-3, A-2-4, and A-2-5; for height of fill of 12 feet and more, A-1, A-3. Structure backfill shall be placed and compacted to not less than 90% density per AASHTO T 180.

12.7.4.2 Construction Requirements

To control shape change from construction activities outside the envelope in trench conditions, the structural backfill envelope shall extend to the trench wall and be compacted against it. Alternatively, the structural backfill must extend an adequate distance to protect the shape of the structure from construction loads. The remaining trench width can be filled with suitable backfill material compacted to meet the requirements of Article 12.7.4.3. In embankment conditions, the minimum structural backfill width shall be 6 feet. Where dissimilar materials not meeting geotechnical filter criteria are used adjacent to each other, a suitable geotextile must be used to avoid migration.

12.7.4.3 Service Requirements

To limit deflections under service loads, the width of the envelope on each side of the structure shall be adequate to limit horizontal compression strain to 1% of the structure's span on each side of the structure. This is a design limit—not a performance limit. Any span increase that occurs is principally due to the consolidation of the side support materials as the structure is loaded during backfilling. These are construction movements that attenuate when full cover is reached.

Limiting horizontal compression strain requires an evaluation of the width and quality of the structural backfill material selected as well as the in situ, embankment or other fill materials within the zone, on each side of the

structure, that extends to a distance equal to the rise of the structure plus its cover height (See Figure 12.7.4A).

Forces acting radially off the small radius corner arc of the structure at a distance d_1 from the structure can be calculated as

$$P_1 = \frac{T}{R_c + d_1} \quad (12.7.4.3-1)$$

where

- P_1 = the horizontal pressure from the structure at a distance d_1 from it (psf)
- d_1 = distance from the structure (ft)
- T = Total dead load and live load thrust in the structure (Article 12.7.2.1-psf)
- R_c = Corner radius of the structure (ft)

The required envelope width beside the pipe, d , can be calculated for a known, allowable bearing pressure as

$$d = \frac{T}{P_{Brg}} - R_c \quad (12.7.4.3-2)$$

where

- d = required envelope width beside the structure (ft)
- P_{Brg} = Allowable bearing pressure to limit compression (strain) in the trench wall or embankment (psf)

The structural backfill envelope shall continue above the crown to the minimum cover level for that structure or, if it is less, to the bottom of the pavement (or granular base course) or the bottom of any relief slab, etc.

12.7.5 End Treatment Design

End treatment selection and design is an integral part of the structural design. It ensures proper support of the ends of the structure while providing protection from scour, hydraulic uplift and loss of backfill due to erosion forces.

12.7.5.1 Standard Shell End Types

The standard end types for the corrugated plate shell are provided in Figure 12.7.5A. Step bevel, full bevel and skewed ends all involve cutting the plates within a ring. Each has its own structural considerations.

Step bevels cut the corner (and side on pear and high profile arch shapes) plates on a diagonal (bevel) to match the fill slope. The following limits apply:

- The rise of the top step must be equal to or greater than the rise of the top arc; thus plates in the top arc are left uncut.
- The bottom step
 - for structures with inverts, must meet the requirements for a top step.
 - for arches, must be a minimum of 6 inches.

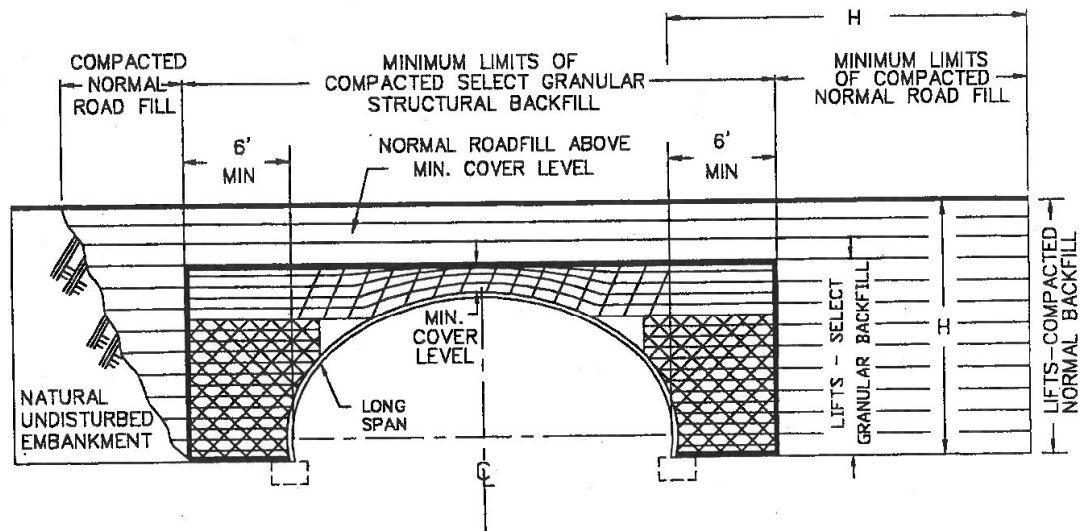
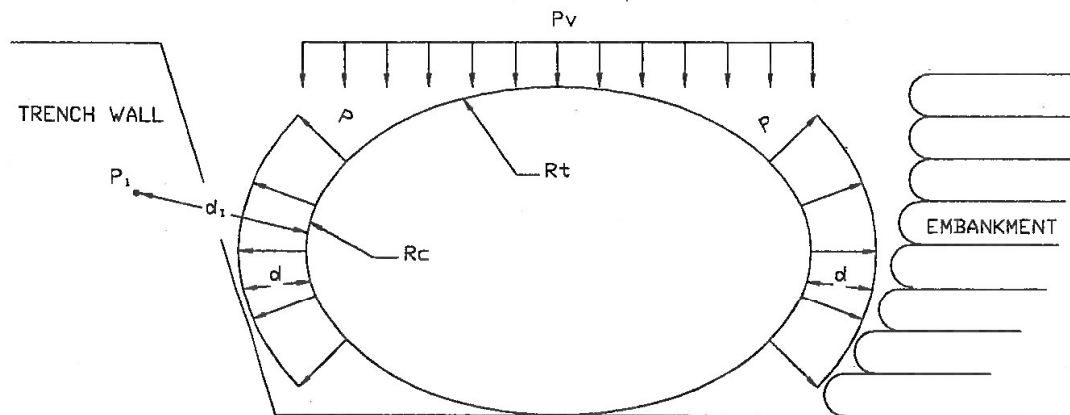

FIGURE 12.7.4A Typical Structural Backfill Envelope and Zone of Structure Influence



R_t = top radius of the structure
 R_c = corner radius of the structure
 d = minimum structural backfill width
 P = the horizontal pressure from the structure at a distance d from it (psf)
 P_v = dead and live load pressure (psf) on the crown

FIGURE 12.7.4B Assumed Pressure Distribution

- The slope of the cut plates generally shall be no flatter than 3:1.
- The upper edge of the cut plates must be bolted to and supported by a structural concrete slope collar, slope pavement, etc.

Full bevel ends are limited to special design only. Structures with full inverts must have a bottom step conforming to the requirements for step bevel ends.

The bevel cut edge of all plates must be supported by a suitable, rigid concrete slope collar.

- Skew cut ends must be fully connected to and supported by a reinforced concrete (or other rigid) headwall. The headwall must extend an adequate distance above the crown of the structure to be capable of reaching the ring compression thrust forces from the cut plates. In addition to normal active earth and live load pressures, the headwall will react to a component of the radial pressure exerted by the structure (See Article 12.7.4.3).

12.7.5.2 Balanced Support

Soil support must be relatively balanced from side to side, perpendicularly across the structure. In lieu of a special design, slopes running perpendicularly across the structure are limited to a maximum of 10%, for

cover heights of 10 feet or less, and to 15% for higher covers.

Unbalanced soil support occurs whenever a structure is skewed to an embankment. When this occurs, the fill must be warped (shaped) to maintain balanced support and to provide an adequate width of backfill and embankment soil to support the ends.

In lieu of a special design, a flattened area running parallel to the structure shall be provided to extend out a distance of 1.5 (rise + cover) beyond the springline.

12.7.5.3 Hydraulic Protection

In hydraulic applications, the structure, which includes the shell, footings, structural backfill envelope and other fill materials within the zone influenced by the structure must be protected.

12.7.5.3.1 Backfill Protection

Loss of backfill integrity through piping action must be considered. If materials prone to piping are used, the structure and ends of the backfill envelope must be adequately sealed to control soil migration and/or infiltration.

12.7.5.3.2 Cut-Off (Toe) Walls

All hydraulic structures with full inverts require upstream and downstream cut-off (toe) walls. Invert plates

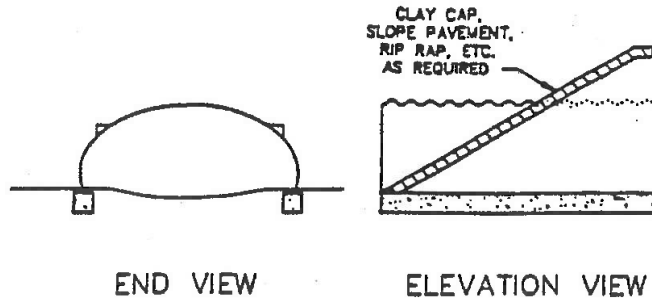

(A) SQUARE END

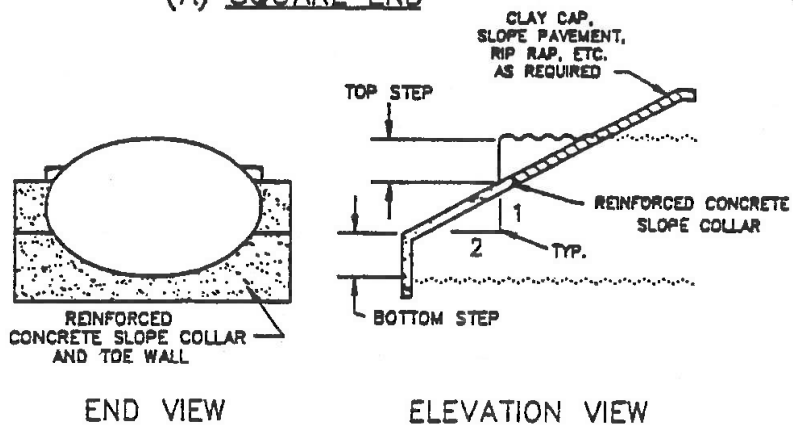

(B) STEP LEVEL

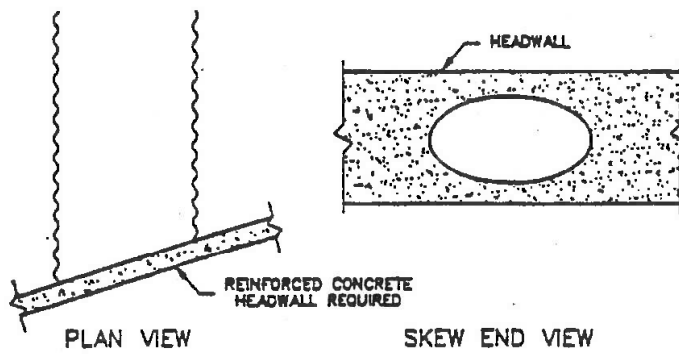

(C) SKEW CUT END
(REQUIRES FULL HEADWALL)

FIGURE 12.7.5A Standard Structure End Types

shall be bolted to cut-off walls at a maximum 20 inch center-to-center spacing using 3/4 inch bolts.

The cut-off wall shall extend to an adequate depth to limit hydraulic percolation to control up-lift forces (Article 12.7.5.3.3) and scour (Article 12.7.5.3.4).

12.7.5.3.3 Hydraulic Uplift

Hydraulic uplift is a design consideration for hydraulic structures with full inverts where the design flow level in the pipe may drop quickly. Resulting hydraulic gradients, with the water level higher in the backfill than in the pipe, must be limited to levels that will not buckle the invert or float the structure. Buckling may be evaluated using Article 12.7.2.3 assuming the span of the structure is twice the invert radius. Where uplift can be a concern, design typically employs adequate cut-off walls and other means to seal off water flow into the structural backfill.

12.7.5.3.4 Scour

Scour design shall meet the requirements of Article 4.4.5.2. Where erodible soils are encountered, varying degrees of conventional means of scour protection may be employed to meet requirements.

Deep foundations such as piles or caissons are not to be used without a special design that considers differential settlement and provides a means to retain the structural backfill if scour proceeds below the pile cap, etc.

12.7.6 Multiple Structures

Care must be exercised on the design of multiple, closely spaced structures to control unbalanced loading. Fills should be kept level over the series of structures when possible. Significant roadway grades across a series of structures require checking of the stability of the flexible structures under the resultant unbalanced loading.

12.8 STRUCTURAL PLATE BOX CULVERTS

12.8.1 General

Structural plate box culverts (hereafter "box culverts") are composite reinforcing rib-plate structures of approximate rectangular shape. Box culverts are intended for shallow covers and low wide waterway openings. The shallow covers and extreme shapes of box culverts require special design procedures. Requirements of Articles 12.1 through 12.7 are not applicable to box culvert designs unless included in Article 12.8 by specific reference.

12.8.1.1 Scope

Article 12.8 presents structural capacity requirements for box culverts based on the load factor method. Standard

shapes, soil requirements, and permissible product details for box culverts in compliance with this specification are defined.

12.8.2 Structural Standards

The design criteria presented in subsequent articles are applicable only to structures in compliance with the standards described in Article 12.8.

12.8.2.1 Structural plate box culverts shall be bolted. The box culvert materials specifications are

Aluminum	Steel
AASHTO M 219	AASHTO M 167

12.8.2.2 Reinforcing ribs shall be an aluminum or steel structural section curved to fit the structural plates. Ribs shall be bolted to the plates so as to develop the plastic moment capacity required. Spacing between ribs shall not exceed 2 feet on the crown and 4.5 feet on the haunch. Rib splices shall develop the plastic moment capacity required at the location of the splice.

12.8.2.3 Plastic moment capacities of ribbed sections may be computed using minimum yield strength values for both rib and corrugated shell. Such computed values may be used for design only after they have been confirmed by representative flexural test data. (Reference Article 10.48.1).

12.8.3 Structure Backfill

12.8.3.1 Structure backfill material shall conform to the requirements of Article 12.7.2.4, compacted to a minimum 95% of standard density based on AASHTO T 99 or 90% of standard density based on AASHTO T 180.

12.8.3.2 Specified structure backfill material shall be 3 feet wide, minimum, at the footing and shall extend upward to the road base elevation.

TABLE 12.8.2A Geometric Requirements for Box Culverts

I.	Span, (S), may vary from 8 ft-9 in. to 25 ft-5 in.
II.	Rise, (R), may vary from 2 ft-6 in. to 10 ft-6 in.
III.	Radius of crown, (r _c) = 24 ft-9 1/2 in. maximum
IV.	Radius of haunch, (r _h) = 2 ft-6 in. minimum
V.	Δ may vary from 50° to 70°
VI.	Length of leg, (D), measured to the bottom of the plate, may vary from 0.4 ft to 5.9 ft.
VII.	Minimum length of rib on leg, (l), is either 19 in.; the length of leg, (D), minus 3 in. or to within 3 in. of the top of a concrete footing, whichever is less.

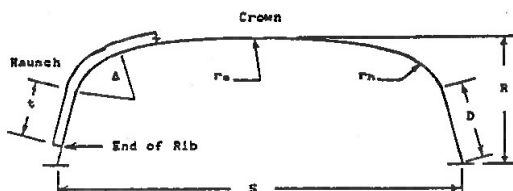

FIGURE 12.8.2A Standard Terminology of Structural Plate Box Culvert Shapes

12.8.4 Design

12.8.4.1 Analytical Basis for Design

Structural requirements for box culverts have been developed from finite element analyses covering the range of structures allowed by Article 12.8.2.

12.8.4.1.1 Structural requirements are based on analyses using two dimensional live loads equivalent to HS 20, 4-wheel, single-axle vehicles. Dead load of soil equals 120 pounds per cubic foot. Coefficients to adjust for other load conditions are contained in Article 12.8.4.3.2.

12.8.4.1.2 Backfill required in Article 12.8.3 is dense granular material. The analyses that provide the basis for this specification were based on conservative soil properties of low plasticity clay (CL) compacted to 90% of standard AASHTO T 99.

12.8.4.2 Load Factor Method

The combined gamma and beta factors to be applied are

$$\begin{aligned} \text{Dead load, load factor} &= 1.5 \\ \text{Live load, load factor} &= 2.0 \end{aligned}$$

The capacity modification factor ϕ is 1.00.

12.8.4.3 Plastic Moment Requirements

Analyses covering the range of box culvert shapes described in Article 12.8.2 have shown moment requirements govern the design in all cases. Effects of thrust were found to be negligible when combined with moment.

Metal box culverts act similar to rigid frames, distributing moment between the crown and haunch on the basis of their relative stiffness. Within limits, increasing the stiffness of one component of the box (either crown or haunch) reduces the portion of the total moment carried by the other.

Article 12.8 provides for this moment distribution within the allowable limits of the moment proportioning

factor (P). P represents the proportion of the total moment that can be carried by the crown of the box culvert and varies with the relative moment capacities of the crown and haunch components. Limits for P are given in Table 12.8.4D.

12.8.4.3.1 The sum of the crown and haunch dead load moments are

$$M_{DL} = \gamma \times 10^{-3} \{ S^3 [0.0053 - 0.00024(S - 12)] + 0.053 (H - 1.4)S^2 \} \quad (12-12)$$

where

- M_{DL} = The sum of the nominal crown and haunch dead load moments (kip-ft/ft)
- S = Box culvert span in feet.
- γ = Soil density (lbs/ft³)
- H = Height of cover from the box culvert rise to top of pavement (ft)

12.8.4.3.2 The sum of the crown and haunch live load moments are

$$M_{LL} = C_{\ell\ell} K_1 S / K_2 \quad (12-13)$$

where

- M_{LL} = The sum of the nominal crown and haunch live load moments (kip-ft/ft)
- $C_{\ell\ell}$ = Live load adjustment coefficient for axle loads, tandem axles, and axles with other than 4 wheels;

$$C_{\ell\ell} = C_1 C_2 AL \quad (12-14)$$

AL = Total axle load on single axle or tandem axles in kips;

- C_1 = Adjustment coefficient for number of axles;
- $C_1 = 1.0$, for single axle;
- $C_1 = (0.5 + S/50)$, for tandem axles, ($C_1 \leq 1.0$);
- S = Box culvert span in feet;
- C_2 = Adjustment coefficient for number of wheels per axle. (Values for C_2 are given in Table 12.8.4A.)
- H = Height of cover from the box culvert rise to top of pavement (ft.)

$$K_1 = \frac{0.08}{(H/S)^{0.2}}, \text{ for } 8 \leq S < 20 \quad (12-15)$$

$$K_1 = \frac{0.08 - 0.002(S - 20)}{(H/S)^{0.2}}, \text{ for } 20 \leq S \leq 26 \quad (12-16)$$

$$K_2 = 0.54H^2 - 0.4H + 5.05, \text{ for } 1.4 \leq H < 3.0 \quad (12-17)$$

$$K_2 = 1.90H + 3, \text{ for } 3.0 \leq H \leq 5.0 \quad (12-18)$$

TABLE 12.8.4A C_2 , Adjustment Coefficient Values for Number of Wheels Per Axle

Wheels per Axle	Cover Depth, ft			
	1.4	2.0	3.0	5.0
2	1.18	1.21	1.24	1.02
4	1.00	1.00	1.00	1.00
8	0.63	0.70	0.82	0.93

12.8.4.3.3 Crown plastic moment capacity ($M_{pc} \phi$), and haunch plastic moment capacity ($M_{ph} \phi$), must be equal to or greater than the proportioned sum of load adjusted dead and live load moments.

$$M_{pc} \geq P[(C_{d1}M_{d1}) + (C_{l1}M_{l1})] \quad (12-19)$$

$$M_{ph} \geq (1.0 - P)[(C_{d1}M_{d1}) + (R_b C_{l1}M_{l1})] \quad (12-20)$$

where

P = Proportion of total moment carried by the crown.
Limits for P are given in Table 12.8.4D;

R_b = Haunch moment reduction factor from Table 12.8.4E.

12.8.4.3.4 Article 12.8 can be used to check the adequacy of manufactured products for compliance with the requirements of this specification. Using the actual crown moment capacity provided by the box culvert under consideration and the loading requirements of the application, Equation (12-19) is solved for the factor P. This factor should fall within the allowable range of Table 12.8.4D. Knowing the factor P, Equation (12-20) is then solved for required haunch moment capacity, which should be less than or equal to the actual haunch moment capacity provided.

TABLE 12.8.4B P, Crown Moment Proportioning Values

Span ft	Allowable Range of P
Less Than 10	0.55 to 0.70
10-15	0.50 to 0.70
15-20	0.45 to 0.70
20-26	0.45 to 0.60

TABLE 12.8.4C R_b , Haunch Moment Reduction Values

Cover Depth, ft			
1.4	2	3	4 to 5
0.66	0.74	0.87	1.00

If Equation (12-19) indicates a higher P factor than permitted by the ranges of Table 12.8.4D, the actual crown is over designed, which is acceptable. However, in this case only the maximum value of P allowed by the table shall be used to calculate the required haunch moment capacity from Equation (12-20).

12.8.4.4 Footing Reactions

The reaction at the box culvert footing may be computed using the following equation

$$V = \gamma(HS/2,000 + S^2/40,000) + AL/[8 + 2(H + R)] \quad (12-21)$$

where

V = Reaction in kips per foot acting in the direction of the box culvert straight side;

γ = Backfill unit weight in pounds per cubic foot;

H = Height of cover over the crown in feet;

S = Span of box culvert in feet;

AL = Axle load in kips;

R = Rise of box culvert in feet.

12.8.5 Manufacturing and Installation

12.8.5.1 Manufacture and assembly of structural plates shall be in accordance with Articles 23.3.1.4, 26.3.2, 26.3.3, 26.3.4, and 26.4.1. Reinforcing ribs shall be attached as shown by the manufacturer. Bolts connecting plates, plates to ribs and rib splices shall be torqued to 150-foot pounds.

12.8.5.2 Sidefill and overfill per Article 12.8.3 shall be placed in uniform layers not exceeding 8 inches in compacted thickness at near optimum moisture with equipment and methods which do not damage or distort the box culvert.

12.8.5.3 Following completion of roadway paving, crown deflection due to live load may be checked. After a minimum of 10 loading cycles with the design live load, the change in rise loaded with the design live load relative to the rise unloaded, should not exceed $\frac{1}{200}$ of the box culvert span.

Appendix III

From the **NEW 2008** "NCSPA Corrugated Steel Pipe Design Manual"

Table 8.6					
Plastic moment strengths "M _p " of corrugated steel pipe (k-ft/ft)					
Wall Thickness (in.)	2-2/3 x 1/2	3 x 1 / 5 x 1	6 x 2	15 x 5-1/2**	16 x 6**
0.064	0.39	0.79			
0.079	0.49	0.99			
0.109 / 0.111*	0.69	1.40	2.66		
0.138 / 0.140*	0.90	1.82	3.44	14.43	
0.168 / 0.170*	1.11	2.24	4.22	17.66	18.46
0.188			4.73	19.75	
0.197					21.70
0.218			5.54	23.07	
0.236					26.34
0.249			6.36	26.39	
0.276					30.78
0.280			7.18	29.72	
0.315					35.00

Notes:
 * Where two thicknesses are provided, the first is for pipe and the second for structural plate.
 ** M_p values for 15 x 5-1/2 and 16 x 6 corrugation are based on a yield strength (F_y) of 44 ksi.

Steel Box Culvert Moment Strength M_p (from 1995 NCSPA Design Data Sheet No. 19, Appendix D)

M_p - for 6" x 2" corrugated steel plate shell, 5 x 3 x 1/2 external steel angle rib reinforcements									
1	Rib Spacing		Steel Plate Shell Thickness (in)						
			0.111	0.140	0.170	0.188	0.218	0.249	0.280
	30"	M_p = (ft-k/ft)	12.4	13.7	14.9	15.6	16.7	17.7	18.7
	24"		14.2	15.7	17.0	17.8	19.0	20.2	21.3
	18"		17.2	18.8	20.4	21.4	22.7	24.0	25.3

M_p - for 6" x 2" Corrugated Steel Plate Shell, Corrugated Plate Stiffener Ribs (6" x 3" Corrugation)								
2	Rib Thicknesses	Rib Spacing		Steel Plate Shell Thickness (in)				
				0.111	0.140	0.170	0.188	0.218
	0.111"	24" Exterior	M_p = (ft-k/ft)	6.4	7.3	8.0		
		12" Exterior		9.4	10.7	11.9		
		24" Exterior & Interior		12.0	12.9	13.8		
	0.140"	24" Exterior		7.4	8.4	9.2	9.9	
		12" Exterior		11.1	12.5	13.7	14.5	
		24" Exterior & Interior		14.6	15.6	16.6	17.2	
	0.170"	24" Exterior		8.3	9.5	10.4	11.0	11.8
		12" Exterior		12.0	14.4	15.2	16.2	17.5
		24" Exterior & Interior		17.5	18.3	19.0	19.5	20.3
	0.188"	24" Exterior			10.1	11.1	11.7	12.6
		12" Exterior			14.7	16.2	17.2	18.6
		24" Exterior & Interior			20.0	20.8	21.3	22.0
	0.218"	24" Exterior				12.1	12.8	14.2
		12" Exterior				17.7	18.8	20.2
		24" Exterior & Interior				23.6	24.0	24.8
	0.249"	24" Exterior					13.9	15.1
		12" Exterior					20.0	21.9
		24" Exterior & Interior					26.8	27.6

M_p - for 15" x 5 1/2" corrugated steel pipe shell (no rib reinforcements); Material with corrugation crests or valleys that have been crimped or otherwise embossed to facilitate curving, do not apply									
3		Steel pipe Shell Thickness (in)							
		0.140	0.170	0.188	0.218	0.249	0.280	0.318	0.377
	M_p = (ft-k/ft)	10.8	13.2	14.8	17.3	19.8	22.3	25.3	30.4

Appendix IV

Aluminum Box Culvert Moment Strength M_p (from contech)

Steel and Aluminum
Structural Plate
Design Guidelines

Table 30. Section Properties of Plates Only¹
9" X 2-1/2" Corrugation

Thickness Inches	Moment of Inertia In. ⁴ /ft.	Section Modulus In. ³ /ft.	Radius of Gyration In.	Area of Section In. ² /ft.	Ultimate Seam Strength kip/ft.
0.100 ²	0.997	0.767	0.844	1.404	28.0
0.125	1.248	0.951	0.844	1.750	41.0
0.150	1.499	1.131	0.845	2.100	54.1
0.175	1.751	1.309	0.845	2.449	63.7
0.200	2.004	1.484	0.846	2.799	73.4
0.225	2.258	1.657	0.847	3.149	83.2
0.250	2.513	1.828	0.847	3.501	93.1

¹ Design Yield Stress is 24 ksi.

² 0.100" Thickness can not be curved.

Table 31. Plate & Rib Composite Section Properties

Rib Type	Metal Thickness, Inches					
	0.125	0.150	0.175	0.200	0.225	0.250
	Plastic Moment Capacity, M_p (kip-ft./ft.)					
No Rib	2.65	3.18	3.71	4.24	4.77	5.30
Type II						
@ 54	4.62	5.46	6.04	6.61	7.17	7.74
@ 27	6.18	7.25	7.94	8.60	9.25	9.87
@ 18	7.41	8.66	9.48	10.26	11.00	11.71
@ 9	10.63	12.13	13.08	14.05	15.03	16.02
Type IV						
@ 54	5.87	6.82	7.43	8.04	8.63	9.21
@ 27	8.32	9.59	10.39	11.14	11.85	12.55
@ 18	10.42	11.90	12.84	13.72	14.57	15.39
@ 9	16.45	18.46	19.41	20.38	21.37	22.37
Type VI						
@ 54	8.74	9.51	10.24	10.95	11.64	12.32
@ 27	13.76	14.33	15.16	16.19	17.36	17.48
@ 18	20.09	20.56	20.79	21.30	21.74	22.58
@ 9	32.24	34.35	36.46	38.54	39.88	40.63

Table 32. Section Properties of ALSP Reinforcing Rib

	Type VI Rib	Type IV Rib	Type II Rib
Alloy	6061T6	6061-T6	6061-T6
Area	3.63 in ²	2.27 in ²	1.71 in ²
Center of Mass	$X_c = .901$ in. $Y_c = 2.261$ in.	$X_c = 0.652$ in. $Y_c = 1.704$ in.	$X_c = 0.645$ in. $Y_c = 1.278$ in.
Moment of Inertia	$I_x = 9.700$ in. ⁴ $I_y = 1.014$ in. ⁴	$I_x = 3.555$ in. ⁴ $I_y = 1.050$ in. ⁴	$I_x = 1.802$ in. ⁴ $I_y = 0.787$ in. ⁴
Radius of Gyration	$R_{xc} = 1.636$ in. $R_{yc} = 0.529$ in.	$R_{xc} = 1.251$ in. $R_{yc} = 0.680$ in.	$R_{xc} = 1.026$ in. $R_{yc} = 0.678$ in.
Section Modulus	$S_x = 4.226$ in. ³	$S_x = 1.90$ in. ³	$S_x = 1.046$ in. ³
Plastic Modulus	$Z_x = 6.218$ in. ³	$Z_x = 2.68$ in. ³	$Z_x = 1.705$ in. ³
Plastic Moment	$M_p = 18.13$ kip-ft.	$M_p = 7.81$ kip-ft.	$M_p = 4.97$ kip-ft.
Yield Strength	$F_y = 35$ ksi	$F_y = 35$ ksi	$F_y = 35$ ksi
Tensile Strength	$F_u = 38$ ksi	$F_u = 38$ ksi	$F_u = 38$ ksi
Minimum Curving Radius	104 in.	104 in.	60 in.

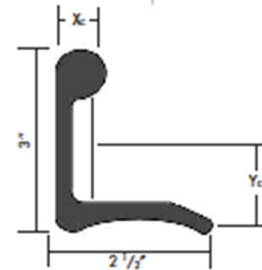
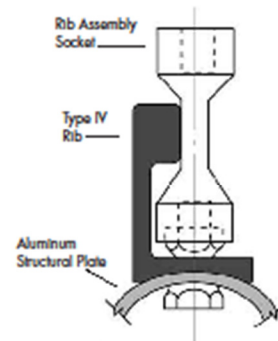

Type II Rib

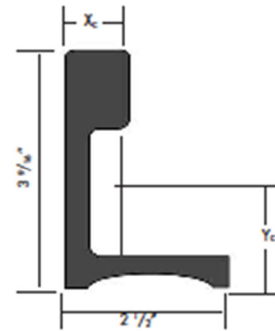

Type IV Rib

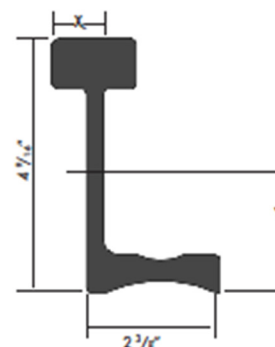

Type VI Rib

Aluminum Structural Plate

Appendix V

APPENDIX V - P_c , Crown Moment Proportioning Values

Crown plastic moment capacity (M_{pc}), and haunch plastic moment capacity (M_{ph}), must be equal to or greater than the proportioned sum of load adjusted dead and live load moments.

$$M_{pc} \geq M_{E(crown)} + M_{LL(crown)}$$

$$M_{ph} \geq M_{E(haunch)} + M_{LL(haunch)}$$

To properly load rate a metal box culvert, the value of P_c selected from the allowable range as shown below, must assign moments to the haunch and crown such that the same percentage of the available moment capacity of each is utilized. Using that specific value of P_c , the structure may be rated by load rating either the haunch or the crown.

Where limits on the proportioning factor (P_c) do not allow for the equal utilization of available haunch and crown moment capacity, load rating must be based on that portion (haunch or crown) that experiences the greatest utilization of its moment capacity. This is done by selecting a proportioning factor (P_c) at one extreme end of the allowable range such that as much moment as possible is assigned to the under-utilized portion (haunch or crown).

The load rating engineer shall manually adjust the P_c value within the allowable range such that Ratio for $[M_{cap(crown)}/M_{cap(haunch)}]$ will be as close as the Ratio for $[M_{LL(crown)}/M_{LL(haunch)}]$. This is a trial and error process.

Span (ft)	Allowable Range of P_c
< 10.0	0.55 - 0.70
10.0 - 15.0	0.50 - 0.70
15.0 - 20.0	0.45 - 0.70
20.0 - 26.0	0.45 - 0.60

Appendix VI

Appendix VI – AASHTO Standard Specification Values for C_2 and R_h

Number of Wheels per Axle Adjustment Coefficient, C_2 (AASHTO LRFD Table 12.9.4.2-1), and Haunch Moment Reduction Factor, R_h (AASHTO LRFD Table 12.9.4.3-2)				
Cover Depth, ft	C_2 (2 wheels/axle)	C_2 (4 wheels/axle)	C_2 (8 wheels/axle)	R_h Value (AASHTO Table 12.8.4C)
< 1.4				
1.400	1.180	1.000	0.630	0.660
1.550	1.188	1.000	0.648	0.680
1.700	1.195	1.000	0.665	0.700
1.850	1.203	1.000	0.683	0.720
2.000	1.210	1.000	0.700	0.740
2.250	1.218	1.000	0.730	0.773
2.500	1.225	1.000	0.760	0.805
2.750	1.233	1.000	0.790	0.838
3.000	1.240	1.000	0.820	0.870
3.500	1.185	1.000	0.848	0.935
4.000	1.130	1.000	0.875	1.000
4.500	1.075	1.000	0.903	1.000
5.000	1.020	1.000	0.930	1.000