

**LARS™**  
*(Load Analysis and Rating System)*  
***Specification Analysis***  
***Manual***

***August 2010***



Bentley Systems, Inc.  
Exton, PA

Bentley, the "B" Bentley logo, and BridgeModeler and LARS are registered or non-registered trademarks of Bentley Systems, Inc. or Bentley Software, Inc. All other marks are the property of their respective owners.

If this software is acquired for or on behalf of the United States of America, its agencies and/or instrumentalities ("U.S. Government"), it is provided with restricted rights. This software and accompanying documentation are "commercial computer software" and "commercial computer software documentation," respectively, pursuant to 48 C.F.R. 12.212 and 227.7202, and "restricted computer software" pursuant to 48 C.F.R. 52.227-19(a), as applicable. Use, modification, reproduction, release, performance, display or disclosure of this software and accompanying documentation by the U.S. Government are subject to restrictions as set forth in this Agreement and pursuant to 48 C.F.R. 12.212, 52.227-19, 227.7202, and 1852.227-86, as applicable. Contractor/Manufacturer is Bentley Systems, Incorporated, 685 Stockton Drive, Exton, PA 19341-0678.

Unpublished - rights reserved under the Copyright Laws of the United States and International treaties.

© 2009, Bentley Systems, Incorporated. All Rights Reserved.

Including software, file formats, and audiovisual displays; may only be used pursuant to applicable software license agreement; contains confidential and proprietary information of Bentley Systems, Incorporated and/or third parties which is protected by copyright and trade secret law and may not be provided or otherwise made available without proper authorization.

TABLE OF CONTENTS

**INTRODUCTION.....5**

**Description of LARS Analysis .....6**

**LARS Analysis Methods for Flexural Members.....7**

**1. STRUCTURAL STEEL AND COMPOSITE STEEL AND CONCRETE.....14**

**1.1 Allowable Stress Design Method .....20**

        1.1.1 Moment Analysis.....21

        1.1.2 Moment Analysis for Hybrid Girders.....25

        1.1.3 Shear Analysis .....28

**1.2 Load Factor Design Method .....37**

        1.2.1 Moment Analysis for Compact Section, Braced Non-Compact and Unbraced  
                Non-Compact.....41

        1.2.2 Moment Analysis for Composite Compact Sections and Braced Non-Compact  
                Sections.....49

        1.2.3 Moment Analysis for Hybrid Girders.....61

        1.2.4 Shear Analysis .....67

        1.2.5 Moment - Shear Interaction .....71

        1.2.6 Stiffener Requirements .....74

        1.2.7 Serviceability Moment Analysis.....76

**2. REINFORCED CONCRETE .....79**

**2.1 Allowable Stress Design Method .....83**

        2.1.1 Moment Analysis.....84

        2.1.2 Shear Analysis .....86

**2.2 Load Factor Design Method .....91**

2.2.1 Moment Analysis .....	92
2.2.2 Shear Analysis .....	100
<b>3. PRESTRESSED CONCRETE AND COMPOSITE PRESTRESSED CONCRETE....</b>	<b>105</b>
<b>3.1 Allowable Stress Design and Load Factor Design Methods.....</b>	<b>113</b>
3.1.1 Moment Analysis .....	114
3.1.2 Low Tendon Analysis .....	134
3.1.3 Shear Analysis .....	137
3.1.4 Serviceability Moment Analysis.....	142
<b>4. TIMBER .....</b>	<b>145</b>

**INTRODUCTION**

**DESCRIPTION OF LARS ANALYSIS**

**LARS ANALYSIS METHODS  
FOR  
FLEXURAL MEMBERS**

### Description of LARS Analysis

The basic analysis methods (i.e., section property, influence lines, and dead load and live load analysis) of the Load Analysis Rating System (LARS) are very similar to those that have been employed in BARS. The majority of analysis results are presented in LARS reports that have headings and labels that fairly clearly describe the associated data. The key values that control the evaluation of the bridge are the moment capacity and available capacity for Live Load + Impact (LL + IMP). These results are produced by executing calculations that are defined by the AASHTO Bridge Specifications, while using the data describing member section properties and the moment and shear values that are applied to the section being analyzed. The calculations are intermixed with logical tests of the intermediate results of the calculations. These logical tests guide the analysis to the various calculations that relate to the type of member section (e.g., non-composite, composite, compact, braced non-compact or unbraced non-compact for steel) within a material of construction type (i.e., for steel, composite steel and concrete, reinforced concrete, prestressed concrete, composite prestressed concrete). The following descriptions are directed toward the clarification of the logical criteria and the calculation methods that produce the moment capacity and the available capacity for LL + IMP for structural steel, composite steel and concrete, reinforced concrete, prestressed concrete and composite prestressed concrete.

The criteria for the selection of, and the computational processes, that make up the analysis processes for the various types of member conditions are listed below. The member analysis conditions for moment analysis are:

	Steel	Reinforced Concrete	Prestressed Concrete	Timber
ASD	Non-Composite Composite	Non-Composite	Non-Composite Composite	Non-Composite
LFD	Non-Composite Compact Braced Non-Compact Unbraced Non-Compact  Composite Compact Braced Non-Compact	Non-Composite Stress Block, Flange Stress Block, Web Compression Steel Non-Prestressed Steel	Non-Composite Stress Block, Flange Stress Block, Web Compression Steel Non-Prestressed Steel  Composite Stress Block, Flange Stress Block, Web Compression Steel Non-Prestressed Steel	

The various criteria logic that is used to determine the calculation methods for the above conditions are referenced in different sections by material of construction. The calculation methods and formulae are described for each of the analysis criteria.

## LARS Analysis Methods for Flexural Members

The following is a discussion of the way in which LARS analyzes flexural members for the various conditions of:

- ASD or LFD analysis methods
- Non-composite or composite action
- Positive or negative bending
- Analysis of top or bottom of section
- Structural steel sections resistance to local buckling and torsional buckling
- Reinforced concrete shape types with reinforcing for tension only, or tension and compression
- Prestressed concrete shape types and analysis methods

The discussion utilizes a series of tables to depict the manner in which LARS performs its analysis for the various interrelationships between each of these conditions. These tables address only the general form of the analysis. Later sections of this document will describe the detailed criteria to select the specific equations, and the formulae used in accordance with the Bridge Specifications.

**Table 1 - Analysis: Non-Composite/Composite Conditions** - describes how LARS analyzes a member section, depending upon its position along the member, and whether the member is composite or non-composite at the location of the section. The “X” characters in the table indicate whether the section is analyzed as:

- composite or non-composite,
- top or bottom of the section,
- + or - moment, and
- within a span or at an interior support.

**Table 1 - BridgeKey Analysis; Non Composite/Composite Conditions**

Section Analyzed	Non Composite Member				Composite Member															
					In Span								Interior Support							
					Non Composite Range				Composite Range				Non Composite Range				Composite Range *			
	Top		Bott		Top		Bott		Top		Bott		Top		Bott		Top		Bott	
+M	-M	+M	-M	+M	-M	+M	-M	+M	-M	+M	-M	+M	-M	+M	-M	+M	-M	+M	-M	
Base Section	X	X	X	X	X	X	X	X	X		X		X	X	X	X		X		X
Composite Section	-	-	-	-					X		X						X		X	

\* Note: When analyzing a Composite Member over a support that has a non-composite range and a composite range abutting exactly at the support, the analysis at CG is performed for both sides of the support, with the lowest rating being reported.

**Table 2 - Basis for Moment Capacity Calculations** - defines the type of capacity calculations performed for SS, CSC, RC, PSC or CPS, for:

- ASD or LFD,
- non-composite or composite,
- + or - moment; top or bottom, and
- in span or at interior supports.

The types of general calculation methods for available capacity for moment are:

- allowable stress,
- ultimate strength, and
- for prestressed concrete, low tendon analysis.

**Table 2 - Basis For Moment Capacity Calculations**

Material Type	Analysis Method	Non Composite Member				Composite Member																
						In Span								Interior Support								
						Non Composite Range				Composite Range				Non Composite Range				Composite Range *				
		Top		Bot		Top		Bot		Top		Bot		Top		Bot		Top		Bot		
		+M	-M	+M	-M	+M	-M	+M	-M	+M	-M	+M	-M	+M	-M	+M	-M	+M	-M	+M	-M	
SS CSC RC	ASD	Ma	Ma	Ma	Ma	Ma	Ma	Ma	Ma	Ma	Ma	Ma	Ma	Ma	Ma	Ma	Ma	Ma	Ma	Ma	Ma	Ma
	LFD	Ma	Ma	Ma	Ma	Ma	Ma	Ma	Ma	Ma	Ma	Ma	Ma	Ma	Ma	Ma	Ma	Ma	Ma	Ma	Ma	Ma
PSC CPS		Ma	Ma	Ma	Ma	Ma	Ma	Ma	Ma	Ma	Ma	Ma	Ma	Ma	Ma	Ma	Ma	Ma	Ma	Ma	Ma	Ma
		Mt	Mt	Mt	Mt	Mt	Mt	Mt	Mt	Mt	Mt	Mt	Mt	Mt	Mt	Mt	Mt	Mt	Mt	Mt	Mt	Mt

Ma = Allowable Stress Moment  
Mu = Ultimate Strength Moment  
Mt = Low Tendon Moment



**Table 3 - LFD - Mu Calculations for Section Conditions - SS and CSC** - describes the general moment capacity calculation methods for the conditions of:

- non-composite or composite,
- + or - moment,
- top or bottom of section, and
- for the cases of:
  - compact,
  - braced non-compact, and
  - four cases of unbraced non-compact sections.

The general calculation methods are defined using the AASHTO Standard Bridge Specification notations.

**Table 3 - LFD - Mu Calculations For Section Conditions - SS & CSC**

		Non Composite						Composite							
		Compact Section	Braced NonCompact Section	UnBraced Non Compact Section				Compact Section			Braced NonCompact Section	UnBraced Non Compact Section			
				Case 1	Case 2	Case 3	Case 4	Case I	Case IIA	Case IIB		Case 1	Case 2	Case 3	Case 4
Top	+M	FyZ	FySt	MrRb	MrRb	MrRb	MrRb	Mp	Mp	Mp	-	-	-	-	-
	-M	FyZ	FySt	MrRb	MrRb	MrRb	MrRb	-	-	-	FySt	MrRb	MrRb	MrRb	MrRb
Bottom	+M	FyZ	FySb	MrRb	MrRb	MrRb	MrRb	Mp	Mp	Mp	-	-	-	-	-
	-M	FyZ	FySb	MrRb	MrRb	MrRb	MrRb	-	-	-	FySb	MrRb	MrRb	MrRb	MrRb

**Table 4 - LFD - Mu Calculations for Section Types - RC** - describes the general moment capacity calculation methods for the conditions of:

- rectangular, T or I sections,
- stress block in flange or in stem,
- + or - moment, and
- with only tension reinforcing steel, or with both tension and compression reinforcing steel.

<b>Table 4 - LFD - Mu Calculations For Section Conditions - RC</b>							
		Rectangular Section		T Section		I Section	
		Tensile Steel	Tensile & Compressive Steel	Tensile Steel	Tensile & Compressive Steel	Tensile Steel	Tensile & Compressive Steel
Top	+M	Mn1	Mn3	Mn2	Mn4	Mn2	Mn4
	-M	Mn1	Mn3	Mn1	Mn3	Mn2	Mn4
Bottom	+M	Mn1	Mn3	Mn2	Mn4	Mn2	Mn4
	-M	Mn1	Mn3	Mn1	Mn3	Mn2	Mn4

Mn1 = Rectangular or T Sections, NA in flange, Tensile Resteel only

Mn2 = T or I Section, NA in stem, Tensile Resteel only

Mn3 = Rectangular or T Sections, NA in flange, Tensile & Compressive Resteel

Mn4 = T or I Section, NA in stem, Tensile & Compressive Resteel

Note: For simplification, T flange is assumed to be on top.

Assumption: Tensile steel only means that there is acting steel in the tension area of the section, but any steel in the compression area of the section is not considered acting.

**Table 5a - Mu Calculations for Section Conditions - PSC** - describes the general moment capacity calculation methods for the conditions of:

- rectangular sections,
- I sections with neutral axis in flange,
- composite I sections with neutral axis in stem, and
- + or - moment.

The moment capacity methods include:

- elastic,
- ultimate, and
- low tendon analysis.

Not depicted in the Table are LARS analysis considerations for non-prestressed tensile and/or compressive reinforcing steel.

**Table 5a - Mu Calculations For Section Conditions - PSC**

		In Span									
		Rectangular Section			I Section, NA in Flange			I Section, NA in Stem			
Top	+M	Elastic	+Me(t)	+Me(t)	+Me(t)	+Me(t)	+Me(t)	+Me(t)	+Me(t)	+Me(t)	+Me(t)
		Ultimate	Mu1	Mu2	Mu3	Mu4	Mu5	Mu6	Mu7	Mu8	Mu9
		Low Tendon	Mt	Mt	Mt	Mt	Mt	Mt	Mt	Mt	Mt
	-M	Elastic	-Me(t)	-Me(t)	-Me(t)	-Me(t)	-Me(t)	-Me(t)	-Me(t)	-Me(t)	-Me(t)
		Ultimate	Mu1	Mu2	Mu3	Mu4	Mu5	Mu6	Mu7	Mu8	Mu9
		Low Tendon	-	-	-	-	-	-	-	-	-
Bottom	+M	Elastic	+Me(b)	+Me(b)	+Me(b)	+Me(b)	+Me(b)	+Me(b)	+Me(b)	+Me(b)	+Me(b)
		Ultimate	Mu1	Mu2	Mu3	Mu4	Mu5	Mu6	Mu7	Mu8	Mu9
		Low Tendon	Mt	Mt	Mt	Mt	Mt	Mt	Mt	Mt	Mt
	-M	Elastic	-Me(b)	-Me(b)	-Me(b)	-Me(b)	-Me(b)	-Me(b)	-Me(b)	-Me(b)	-Me(b)
		Ultimate	Mu1	Mu2	Mu3	Mu4	Mu5	Mu6	Mu7	Mu8	Mu9
		Low Tendon	-	-	-	-	-	-	-	-	-

**Table 5b - Mu Calculations for Section Conditions - CPS** - describes the general moment capacity calculation methods for the conditions of:

- flanged sections with neutral axis in the flange,
- flanged sections with neutral axis in the stem,
- sections in span or at interior supports, and
- + or - moment.

The moment capacity methods include:

- elastic,
- ultimate, and
- low tendon analysis.

Not depicted in the Table are LARS analysis considerations for non-prestressed tensile and/or compressive reinforcing steel.

**Table 5b - Mu Calculations For Section Conditions - CPS**

			In Span					
			Flanged Section, NA in Flange			Flanged Section, NA in Stem		
Top	+M	Elastic	+Me(t)	+Me(t)	+Me(t)	+Me(t)	+Me(t)	+Me(t)
		Ultimate	Mu10	Mu11	Mu12	Mu13	Mu14	Mu15
Low Tendon		Mt	Mt	Mt	Mt	Mt	Mt	
Bottom	-M	Elastic	-Me(t)	-Me(t)	-Me(t)	-Me(t)	-Me(t)	-Me(t)
		Ultimate	Mu10	Mu11	Mu12	Mu13	Mu14	Mu15
Low Tendon		-	-	-	-	-	-	
			At Support					
			Rectangular Section			I Section, NA in Flange		
Top	+M	Elastic	+Me(t)	+Me(t)	+Me(t)	+Me(t)	+Me(t)	+Me(t)
		Ultimate	Mu1	Mu2	Mu3	Mu4	Mu5	Mu6
Low Tendon		Mt	Mt	Mt	Mt	Mt	Mt	
Bottom	-M	Elastic	-	-	-	-	-	-
		Ultimate	Mu10	Mu11	Mu12	Mu13	Mu14	Mu15
Low Tendon		-	-	-	-	-	-	
Top	+M	Elastic	+Me(b)	+Me(b)	+Me(b)	+Me(b)	+Me(b)	+Me(b)
		Ultimate	Mu10	Mu11	Mu12	Mu13	Mu14	Mu15
Low Tendon		Mt	Mt	Mt	Mt	Mt	Mt	
Bottom	-M	Elastic	-	-	-	-	-	-
		Ultimate	Mu10	Mu11	Mu12	Mu13	Mu14	Mu15
Low Tendon		-	-	-	-	-	-	

**SECTION 1**

**STRUCTURAL STEEL**

**AND**

**COMPOSITE STEEL AND CONCRETE**

---

**Structural Steel (SS)/Composite Steel and Concrete (CSC)<sup>1</sup>**

- $a$  = Depth of stress block (Article 10.50.1.1).
- $(A_s)_c$  = Area of reinforced steel in the slab.
- $(A_s f_y)_c$  = Product of the area and yield point of that part of reinforcement which lies in the compression zone of the slab.
- $A_f$  = Area of flange (Articles 10.48.2.1 or 10.53.1.2).
- $A_{fc}$  = Area of compression flange (Article 10.48.4.1).
- $A_i$  = Area of each element (i.e., top flange, web, bottom flange, etc.)
- $A_s$  =  $(A_s)_c$
- $A_w$  = Area of web of beam (Article 10.53.1.2).
- $b$  = Effective flange width of slab (Article 10.50.1.1.1).
- $C$  = Capacity of section.
- $C'$  = Compression force in top portion of section.
- $C_b$  = Bending coefficient (Article 10.48.4.1).
- $C_{SLAB}$  = Capacity of slab.
- $C_{STL}$  = Capacity of steel section.
- $Cap_{AVAIL}$  = Available moment capacity for Live Load + Impact.
- $d$  = Depth of beam or girder (Article 10.48.4.1).
- $d_o$  = Spacing of intermediate stiffener (Article 10.48.8).
- $(d_s)_c$  = Distance to the neutral axis of reinforcing steel in slab from top of slab.
- $d_y^i$  = Distance to the bottom of girder or beam from centroid of each element.

---

<sup>1</sup> Selected symbols and references are based on AASHTO Standard Specifications for Highway Bridges, Sixteenth Edition, while other symbols and references are unique to LARS.

---

$D$	=	Clear unsupported distance between flange components (Articles 10.34.3, 10.34.4, 10.34.5, 10.37.2, 10.48.1, 10.48.2, 10.48.5, 10.48.8, 10.49.2, 10.49.3.2, 10.50, and 10.50.2.1).
$D_c$	=	Clear distance between the neutral axis and the compression flange (Article 10.48.2.1(b), 10.48.4.1, 10.49.2, 10.49.3 and 10.50(d)).
$D_{cp}$	=	Depth of the web in compression at the plastic moment (Articles 10.50.1.1.2 and 10.50.2.1).
$D_w$	=	D
$f_b$	=	Computed compressive bending stress (Articles 10.34.2 and 10.34.3).
$f'_c$	=	Unit ultimate compressive strength of concrete as determined by cylinder tests at age of 28 days, psi (Articles 10.38.1 and 10.50.1.1.1).
$f_v$	=	Unit shear stress (Article 10.34.4.4).
$f_y$	=	Specified yield stress of reinforcing steel.
$F$	=	Factor for rating type (inventory, operating, posting, etc.).
$F_v$	=	Allowable shear stress (Articles 10.34.4 and 10.40.2.2).
$F_y$	=	Specified minimum yield point of steel.
$F_{yf}$	=	Specified minimum yield strength of the flange (Articles 10.48.1.1 and 10.53.1).
$F_{yw}$	=	Specified minimum yield strength of the web (Article 10.53.1).
$HybM_{CAP}$	=	Moment capacity of a hybrid member.
$I_y$	=	Moment of inertia of member about the vertical axis in the plane of the web (in <sup>4</sup> ) (Article 10.48.4.1).
$I_{yc}$	=	Moment of inertia of compression flange about the vertical axis in the plane of the web (in <sup>4</sup> ) (Article 10.48.4.1).
$J$	=	St. Venant torsional constant (Article 10.48.4.1).
$L_b$	=	Unbraced length (Articles 10.48.1.1, 10.48.2.1 and 10.48.4.1).
$L_p$	=	Limited unbraced length (Article 10.48.4.1).
$L_r$	=	Limited unbraced length (Article 10.48.4.1).



- $M$  = Maximum bending moment (Article 10.48.8).
- $M_1$  and  $M_2$  = Moments at two adjacent braced points (Article 10.48.4.1).
- $M_{ac}$  = Available member capacity for LL + IMP.
- $M_l$  = Live load moment at the section.
- $M_{dl}$  = Dead moment at the section.
- $M_p$  = Full plastic moment of the section.
- $M_r$  = Lateral torsional buckling moment or yield moment (Article 10.48.4.1).
- $M_{sdl}$  = Superimposed dead load moment at the section.
- $M_u$  = Maximum bending strength (Articles 10.48, 10.50.1, 10.50.2, and 10.53.1).
- $M_y$  = Moment capacity at first yield (Article 10.50.1.1.2).
- $M_{CAP}$  = Moment capacity of the section.
- $M_{LL+IMP}$  = Sum of Live Load and Impact moment.
- $MV_{CAP}$  = Maximum shear capacity under moment/shear interaction.
- $r'$  = Radius of gyration in inches of the compression flange about the axis in the plane of the web (Article 10.48.4.1).
- $r_y$  = Radius of gyration with respect to the Y-Y axis (Article 10.48.1.1).
- $R$  = Reduction factor for hybrid girder with LFD (Article 10.53.1.2).
- $R_A$  = Reduction factor for hybrid girder with ASD.
- $R_b$  = Bending capacity reduction factor (Article 10.48.4.1).
- $R_{LC}$  = Ratio factor for a hybrid member.
- $S$  = Section modulus of a non-composite section.
- $S_{n=n}$  = Section modulus of composite section with (n=n).
- $S_{n=3n}$  = Section modulus of a composite section with (n=3n).

---

$S_x$	=	S
$S_{xc}$	=	Section modulus with respect to the compression flange (in <sup>3</sup> ) (Article 10.48.4.1).
$t_f$	=	Thickness of the flange.
$t_s$	=	Effective thickness of slab.
$t_{tf}$	=	Thickness of top flange (Article 10.50.1.1.1).
$t_w$	=	Web thickness, in (Articles 10.34.3, 10.34.4, 10.34.5, 10.37.2, 10.48, 10.49.2, and 10.49.3).
$V$	=	Shearing force (Article 10.48.8).
$V_{dl}$	=	Dead load shear at a section.
$V_{sdl}$	=	Superimposed dead load shear at a section.
$V_u$	=	Maximum shear force (Articles 10.48.8, and 10.53.1.4).
$V_{AVAIL}$	=	Available shear capacity for Live Load + Impact.
$V_{CAP}$	=	Shear capacity.
$V_{DL}$	=	$V_{dl}$
$V_{LL+IMP}$	=	Sum of Live Load and Impact shear.
$V_{SDL}$	=	$V_{sdl}$
$\bar{y}$	=	Location of steel sections from neutral axis (Article 10.50.1.1.1).
$Z$	=	Plastic section modulus (Articles 10.48.1 and 10.53.1.1).
$\lambda$	=	A constant related to limitation of $D_c/t_w$ .
$\beta$	=	Area of the web divided by the area of the tension flange, $A_w/A_f$ (Articles 10.40.2, and 10.53.1.2).
$\phi$	=	Distance from the outer edge of the tension flange to the neutral axis divided by the depth of the steel section (Article 10.40.2).

$\alpha$  = Inclination angle of a bent up reinforcement or minimum specified yield strength of the web divided by the minimum specified yield strength of the tension flange (Article 10.40.2).

$\rho$  =  $F_{yw}/F_{yf}$  (Article 10.53.1.2).

**SECTION 1.1**

**STRUCTURAL STEEL**

**AND**

**COMPOSITE STEEL AND CONCRETE**

**ALLOWABLE STRESS DESIGN METHOD**

## Structural Steel (SS)/Composite Steel and Concrete (CSC)

The various criteria logic that is used to determine the calculation methods for the above listed conditions are referenced below by number. The calculation methods and formulae are referenced by number.

### ASD

ASD analysis will be performed for every flexural member that has data sufficient for this analysis, regardless of whether an LFD analysis is requested.

#### Non-Composite:

- A member will be considered as non-composite if the member is designed as SS.
- The values for available capacity for LL + IMP and moment capacity for all non-composite members are calculated by the formulae of MS-1a and MS-1b for non-hybrid girders, and MH-1a and MH-1b for hybrid girders.
- The radius for all available capacity for LL + IMP and shear capacity for all non-composite members are calculated by the formulae of VS-1a and VS-1b, and VS2.1a and VS.1b through VS-2.3a and VS-2.3b.

#### Composite:

- A member will be considered as composite if the member is designed as CSC, and concrete slab has been described.
- The values for available capacity for LL + IMP and moment capacity for all composite members are calculated by the formulae of MS-2a and MS-2b.

**SECTION 1.1.1**

**STRUCTURAL STEEL**

**AND**

**COMPOSITE STEEL AND CONCRETE**

**ALLOWABLE STRESS DESIGN METHOD**

**MOMENT ANALYSIS**

**Structural Steel (SS)/Composite Steel and Concrete (CSC)  
ASD  
Moment Analysis Method for SS Member**

The following are descriptions of the methods used by LARS to perform ASD member moment analysis when the structural steel member section is **non-composite** (i.e., there is no concrete slab acting compositely with steel). The moment capacity is calculated by the formula in MS-1a, and the available capacity is calculated for the formula in MS-1b.

MS-1a:

For a structural steel member, the maximum moment strength at the section  $M_{CAP}$  is calculated as follows, in accordance with Bridge Specification 10.32.3.1:

Compression Flange  $M_{CAP} = F_b S$ , and Tension Flange  $M_{CAP} = 0.55 F_y S$

$$\text{Inventory: } F_b = \frac{91 \times 10^6 C_b}{S_{xc} (F.S.)} \left( \frac{I_{yc}}{l} \right) \sqrt{.772 \frac{J}{I_{yc}} + 9.87 \left( \frac{d}{l} \right)^2} \leq 55 F_y$$

where (F.S.) = 1.82

$$\text{Operating: } F_b = \frac{91 \times 10^6 C_b}{S_{xc} (F.S.)} \left( \frac{I_{yc}}{l} \right) \sqrt{.772 \frac{J}{I_{yc}} + 9.87 \left( \frac{d}{l} \right)^2} \leq 75 F_y$$

where (F.S.) = 1.34

$C_b = 1.75 + 1.05 (M_1/M_2) + 0.3 (M_1/M_2)^2 \leq 2.3$  where  $M_1$  is the smaller and  $M_2$  the larger end moment in the unbraced segment of the beam;  $M_1/M_2$  is positive when the moments cause reverse curvature and negative when bent in single curvature.

$l =$  Length, in inches, of unsupported flange between lateral connections, knee braces, or other points of support.

$I_{yc} =$  Moment of inertia of compression flange about the vertical axis in the place of the web in<sup>4</sup>

$D =$  Depth of girder, in.

$$J = \frac{\left[ (bt^3)_c + (bt^3)_t + Dt_w^3 \right]}{3}$$

$S_{xc} =$  Section modulus with respect to compression flange (in.<sup>3</sup>).

$E =$  Modulus of elasticity of steel.

$r =$  Governing radius of gyration.

$L =$  Actual unbraced length.

MS-1b:

The value of the available capacity for LL + IMP moment at the section is calculated as follows:

$$M_{AVAIL} = M_{CAP} [F] \pm M_{dl} \pm M_{sdl}$$

where for inventory:  $F = 0.55$ , and for operating and posting:  $F = 0.75$

**Structural Steel (SS)/Composite Steel and Concrete (CSC)**  
**ASD**  
**Moment Analysis Method for CSC Member**

The following are descriptions of the methods used by LARS to perform ASD member moment analysis when the composite steel and concrete member section is **composite** (i.e., there is a concrete slab acting compositely with steel). The moment capacity is calculated by the formula in MS-2a, and the available capacity is calculated by the formula in MS-2b.

MS-2a:

For a composite steel and concrete member, the maximum moment strength at the section  $M_{CAP}$  is calculated as follows:

$$M_{CAP} = M_{AVAIL} \pm M_{dl} \pm M_{sdl}$$

MS-2b:

The value of the available capacity for LL + IMP moment at the section is calculated as follows:

$$M_{AVAIL} = \left[ F_y (F) - \frac{M_{dl}}{S} - \frac{M_{sdl}}{S_{n=3n}} \right] S_{s=s}$$

where for inventory:  $F = 0.55$ , and

for operating and posting:  $F = 0.75$



**SECTION 1.1.2**

**STRUCTURAL STEEL**

**AND**

**COMPOSITE STEEL AND CONCRETE**

**ALLOWABLE STRESS DESIGN METHOD**

**MOMENT ANALYSIS**

**FOR**

**HYBRID GIRDERS**

**Structural Steel (SS)/Composite Steel and Concrete (CSC)**  
**ASD**  
**Hybrid Girders**

Specification	Reduction Factor	Page
10.40.2	Non-Composite/Composite	26

**Structural Steel (SS)/Composite Steel and Concrete (CSC)**  
**ASD**  
**Moment Analysis Method for SS/CSC Hybrid Member**

The following are descriptions of the methods used by LARS to perform ASD member moment analysis when the structural steel/composite steel and concrete member section is of hybrid nature (i.e., the strength in the web is lower than one or both of the flanges). The moment capacity is calculated by the formula in MH-1a, and the available capacity is calculated by the formula in MH-1b.

MH-1a:

For a SS/CSC hybrid member, the maximum moment strength at the section *Hyb*  $M_{CAP}$  is calculated as follows, in accordance with Bridge Specification 10.40.2:

$$\text{Reduction Factor} = R_A = 1 - \frac{\beta\phi(1-\alpha)^2(3-\phi+\phi\alpha)}{6 + \beta\phi(3-\phi)}$$

$$\text{Hyb } M_{CAP} = R_A(M_{CAP})$$

For value of  $M_{CAP}$  = Moment Capacity, refer to Moment Analysis.

MH-1b:

The value of the available capacity for LL + IMP moment at the section is calculated as follows:

$$CAP_{AVAIL} = [HybM_{CAP}][F] \pm M_{dl} \pm M_{sdl}$$

where for inventory:  $F = 0.55$ , and

for operating and posting:  $F = 0.75$

**SECTION 1.1.3**

**STRUCTURAL STEEL**

**AND**

**COMPOSITE STEEL AND CONCRETE**

**ALLOWABLE STRESS DESIGN METHOD**

**SHEAR ANALYSIS**

**Structural Steel (SS)/Composite Steel and Concrete (CSC)**  
**ASD**

Specification	Transverse Stiffener	Longitudinal Stiffener	$\frac{D_w}{t_w}$	Page
10.34.4.1	N	N	$\left(\frac{D_w}{t_w}\right) \leq 170$	29
10.34.4.2	Y	Y*	If $\left(\frac{D_w}{t_w}\right) < \frac{6000\sqrt{k}}{\sqrt{F_y}}$	30
			If $\frac{6000\sqrt{k}}{\sqrt{F_y}} \leq \frac{D_w}{t_w} \leq \frac{7500\sqrt{k}}{\sqrt{F_y}}$	31
			If $\left(\frac{D_w}{t_w}\right) > \frac{7500\sqrt{k}}{\sqrt{F_y}}$	32

\* If no longitudinal stiffener is provided, then  $D_w/t_w$  shall meet the following criteria:

$$D_w/t_w \leq 330 \text{ for } F_y = 36,000$$

$$D_w/t_w \leq 280 \text{ for } F_y = 50,000$$

$$D_w/t_w \leq 230 \text{ for } F_y = 70,000$$

$$D_w/t_w \leq 210 \text{ for } F_y = 90,000$$

$$D_w/t_w \leq 200 \text{ for } F_y = 100,000$$

If not, a warning message is issued.

Check  $(d_o/D_w) > 3$ .

If true, issue a warning message.

**Structural Steel (SS)/Composite Steel and Concrete (CSC)**  
**ASD**  
**Shear Analysis Method of SS/CSC Member**

The following are descriptions of the methods for LARS to perform ASD shear analysis when the member web is **unstiffened**. The shear capacity is calculated by the formula in VS-1a, and the available capacity is calculated by the formula in VS-1b.

Note: Check  $D/t_w > 170$ . If true, issue a warning message.

VS-1a:

For a SS/CSC member with web unstiffened, the maximum shear strength at the section  $V_{CAP}$  is calculated as follows, in accordance with Bridge Specification 10.34.4.1:

$$F_v = \frac{7.33 \times 10^7}{(D_w / t_w)^2} \leq \frac{F_y}{3}$$

$$V_{CAP} = F_v (D_w) (t_w)$$

VS-1b:

The value of the available capacity for LL + IMP shear at the section is calculated as follows:

$$V_{AVAIL} = [V_{CAP}] [F] \pm V_{DL} + V_{SDL}$$

where for inventory:  $F = 0.55$ , and

for operating and posting:  $F = 0.75$

**Structural Steel (SS)/Composite Steel and Concrete (CSC)**  
**ASD**  
**Shear Analysis Method for SS/CSC Member**

The following are descriptions of the methods for LARS to perform ASD shear analysis when the member web is **stiffened transversely and/or longitudinally**. The shear capacity is calculated by the formula in VS-2.1a, and the available capacity is calculated by the formula in VS-2.1b. If longitudinal stiffener is not provided, check  $D_w/t_w$  and issue a warning message accordingly.

VS-2.1a:

For a SS/CSC member with web stiffened transversely and/or longitudinally, the maximum shear strength at the section  $V_{CAP}$  is calculated as follows, in accordance with Bridge Specification 10.34.4.2:

$$\text{If } \left( \frac{D_w}{t_w} \right) < 6000 \frac{\sqrt{k}}{\sqrt{F_y}} ,$$

$$\text{where } k = 5 + \frac{5}{\left( \frac{d_o}{D_w} \right)^2} ,$$

$$\text{then } C = 1.0$$

$$\text{and } V_{CAP} = \frac{F_y}{3} \left[ C + \frac{0.87(1-C)}{\sqrt{1 + \left( \frac{d_o}{D_w} \right)^2}} \right] = \frac{F_y}{3}$$

VS-2.1b:

The value of the available capacity for LL + IMP shear at the section is calculated as follows:

$$V_{AVAIL} = [V_{CAP}] [F] \pm V_{DL} \pm V_{SDL}$$

$$\text{where for inventory: } F = 0.55, \text{ and}$$

$$\text{for operating and posting: } F = 0.75$$

**Structural Steel (SS)/Composite Steel and Concrete (CSC)**  
**ASD**  
**Shear Analysis Method for SS/CSC Member**

The following are descriptions of the methods for LARS to perform ASD shear analysis when the member web is **stiffened transversely and/or longitudinally**. The shear capacity is calculated by the formula in VS-2.2a, and the available capacity is calculated by the formula in VS-2.2b. If longitudinal stiffener is not provided, check  $D_w/t_w$  and issue a warning message accordingly.

VS-2.2a:

For a SS/CSC member with web stiffened transversely and/or longitudinally, the maximum shear strength at the section  $V_{CAP}$  is calculated as follows, in accordance with Bridge Specification 10.34.4.2:

$$\text{If } \frac{6000\sqrt{k}}{\sqrt{F_y}} \leq \frac{D_w}{t_w} \leq \frac{7500\sqrt{k}}{\sqrt{F_y}},$$

$$\text{where } k = 5 + \frac{5}{\left(\frac{d_o}{D_w}\right)^2},$$

$$\text{then } C = \frac{6000\sqrt{k}}{\left(\frac{D_w}{t_w}\right)\sqrt{F_y}}$$

$$\text{and } V_{CAP} = \frac{F_y}{3} \left[ C + \frac{0.87(1-C)}{\sqrt{1 + \left(\frac{d_o}{D_w}\right)^2}} \right]$$

VS-2.2b:

The value of the available capacity for LL + IMP shear at the section is calculated as follows:

$$V_{AVAIL} = [V_{CAP}] [F] \pm V_{DL} \pm V_{SDL}$$

where for inventory:  $F = 0.55$ , and

for operating and posting:  $F = 0.75$



**Structural Steel (SS)/Composite Steel and Concrete (CSC)**  
**ASD**  
**Shear Analysis Method for SS/CSC Member**

The following are descriptions of the methods for LARS to perform ASD shear analysis when the member web is **stiffened transversely and/or longitudinally**. The shear capacity is calculated by the formula in VS-2.3a, and the available capacity is calculated by the formula in VS-2.3b. If longitudinal stiffener is not provided, check  $D_w/t_w$  and issue a warning message accordingly.

VS-2.3a:

For a SS/CSC member with web stiffened transversely and/or longitudinally, the maximum shear strength at the section  $V_{CAP}$  is calculated as follows, in accordance with Bridge Specification 10.34.4.2:

$$\text{If } \left( \frac{D_w}{t_w} \right) > \frac{7500\sqrt{k}}{\sqrt{F_y}},$$

$$\text{where } k = 5 + \frac{5}{\left( \frac{d_o}{D_w} \right)^2}$$

$$\text{then } C = \frac{4.5(10)^7(k)}{\left( \frac{D_w}{t_w} \right)^2 F_y}$$

$$\text{and } V_{CAP} = \frac{F_y}{3} \left[ C + \frac{0.87(1-C)}{\sqrt{1 + \left( \frac{d_o}{D_w} \right)^2}} \right]$$

VS-2.3b:

The value of the available capacity for LL + IMP shear at the section is calculated as follows:

$$V_{AVAIL} = [V_{CAP}] [F] \pm V_{DL} \pm V_{SDL}$$

where for inventory:  $F = 0.55$ , and

for operating and posting:  $F = 0.75$

**Structural Steel (SS)/Composite Steel and Concrete (CSC)**  
**ASD**  
**Moment - Shear Interaction Analysis**

Specification	Moment - Shear Interaction	Page
10.34.4.4	$V > 0.75 V_u$	34

$$V = V_{dl} + V_{sdl} + V_{LL+IMP}$$

**Structural Steel (SS)/Composite Steel and Concrete (CSC)  
ASD  
Moment Shear Interaction Analysis Method for SS/CSC Member**

The following is a description of a method for LARS to check ASD moment shear interaction analysis when the member section is simultaneously subjected to bending moment and shear such as  $V > 0.6 V_u$ .

$$\text{If } MV_{CAP} > M_{CAP} \left[ 0.754 - 0.34 \frac{f_y}{F_y} \right], \text{ issue a warning message.}$$

**Structural Steel (SS)/Composite Steel and Concrete (CSC)**  
**ASD**  
**Stiffener Requirement**

Specification	$D_w/t_w$	Requirements
10.34.3.1	$\frac{D_w}{t_w} \leq \frac{23000}{\sqrt{f_b}} \leq 170$	No stiffener required
10.34.3.1	$\frac{23000}{\sqrt{f_b}} < \frac{D_w}{t_w} \leq \frac{46000}{\sqrt{f_b}} \leq 340$	Transverse stiffeners required No longitudinal stiffener required
10.34.3.2.1	$\frac{46000}{\sqrt{f_b}} < \frac{D_w}{t_w}$	Transverse and longitudinal stiffeners required

Note 1:  $f_b = 20,000$ ,  $23,000 / \sqrt{f_b} = 162.6 \approx 170$

Note 2:  $f_b = 20,000$ ,  $46,000 / \sqrt{f_b} = 325.3 \approx 340$

**SECTION 1.2**

**STRUCTURAL STEEL**

**AND**

**COMPOSITE STEEL AND CONCRETE**

**LOAD FACTOR DESIGN METHOD**

**Structural Steel (SS)/Composite Steel and Concrete (CSC)**  
**LFD**  
**Qualifications for Determining Analysis Method for Member**

The following are descriptions of the qualifications to determine the methods for LARS to perform LFD member analysis. These qualifications are derived from the AASHTO Standard Specifications for Highway Bridges, Sixteenth Edition, 1996. The qualifications for analysis selection are listed separately for each LFD condition, along with references to the appropriate Specification Number. The LFD analysis types are as follows:

- Non-Composite
  - Compact
  - Braced Non-Compact
  - Unbraced Non-Compact
  
- Composite
  - Compact
  - Non-Compact

**Structural Steel (SS)/Composite Steel and Concrete (CSC)  
LFD**

The various criteria logic that is used to determine the calculation methods for the above listed conditions are referenced below by number. The calculation methods and formulae are referenced by number.

Non-Composite:

A member will be considered as non-composite if it is designated as SS.

1. Compact

- The criteria to determine whether or not a member is to be analyzed by non-composite, compact methods is determined by the logic and calculations shown on page 42.
- The values for available capacity for LL + IMP and moment capacity and for non-composite, compact members are calculated by the formulae discussed under SS-M1 and SS-M1b on page 45.

2. Braced Non-Compact

- The criteria to determine whether or not a member is to be analyzed by non-composite, braced, non-compact methods is determined by the logic and calculations shown on page 43.
- The values for available capacity for LL + IMP and moment capacity for non-composite, braced, non-compact members are calculated by the formulae discussed under SS-M2a and SS-M2b on page 45.

3. Unbraced Non-Compact

- The criteria to determine whether or not a member is to be analyzed by non-composite, unbraced, non-compact methods is determined by the logic and calculations shown on page 44.
- The values for available capacity for LL + IMP and moment capacity for non-composite, unbraced, non-compact members are calculated by the formulae discussed under SS-M3a and SS-M3b on page 48, where  $M_r$  used in SS-M3a is computed for the controlling case (I through IV) outlined under SS-M3 on pages 1-46 and 1-47.

Composite:

A member will be considered as composite if the concrete slab has been described.

1. Compact

- The criteria to determine whether or not a member is to be analyzed by composite, compact methods is determined by the logic and calculations shown on page 1-50 to 1-55.
- The values for available capacity for LL + IMP and moment capacity and for composite, compact members are calculated by the formulae discussed in CSC-M1a and CSC-M1b on pages 1-56 and 1-57.

2. Braced Non-Compact

- The criteria to determine whether or not a member is to be analyzed by composite, braced, non-compact methods is determined by the logic and calculations shown on page 1-50 and 1-57.
- The values for available capacity for LL + IMP and moment capacity for composite, braced, non-compact members are calculated by the formulae discussed in CSC-M2a and CSC-M2b on page 1-58.

3. Unbraced Non-Compact

- The criteria to determine whether or not a member is to be analyzed by composite, unbraced, non-compact methods is determined by the logic and calculations of 1-46 and 1-47.
- The values for available capacity for LL + IMP and moment capacity for composite, unbraced, non-compact members are calculated by the formulae of 1-48.



**SECTION 1.2.1**

**STRUCTURAL STEEL**

**LOAD FACTOR DESIGN METHOD**

**MOMENT ANALYSIS**

**FOR:**

- **COMPACT SECTION**
- **BRACED NON-COMPACT**
- **UNBRACED NON-COMPACT**

**Structural Steel Section (SS)  
LFD  
Check for Non-Composite, Compact Section Compression Flange**

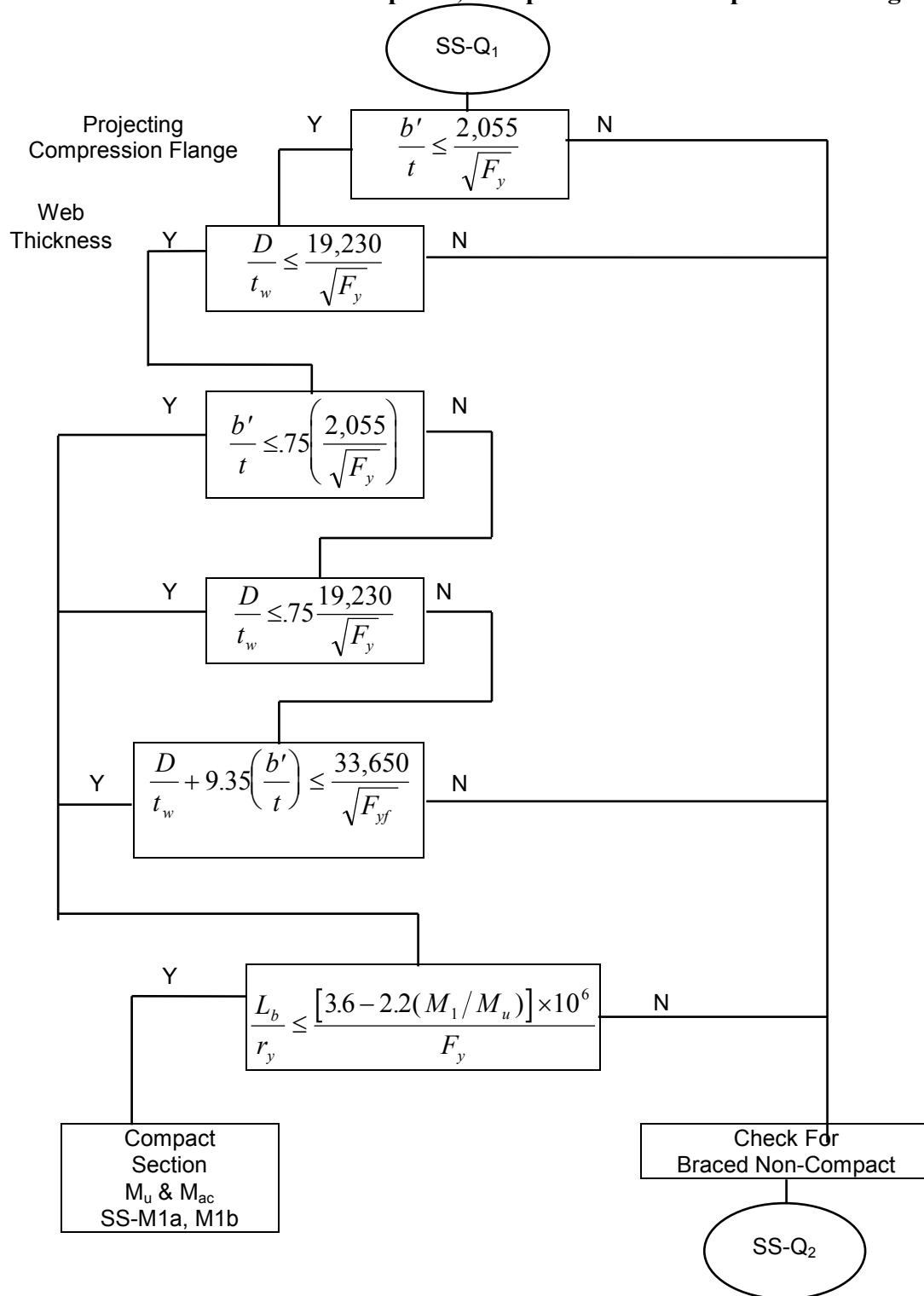

Note:  $M_u$  = Moment Capacity and  $M_{ac}$  = Available Member Capacity for LL+IMP

**Structural Steel Section (SS)  
LFD  
Check for Non-Composite, Braced Non-Compact Section Compression Flange**

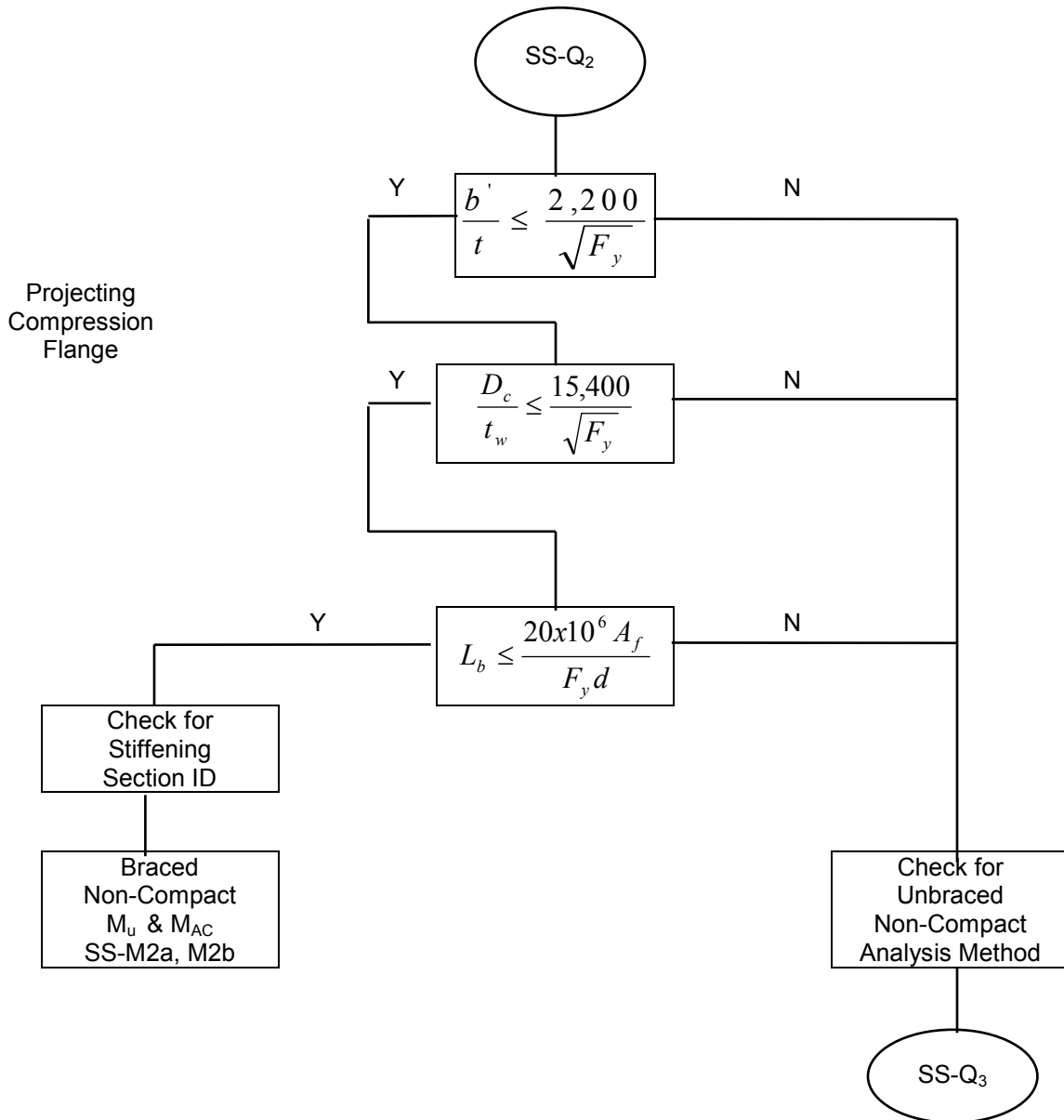

Note:  $M_u$  = Moment Capacity  
 $M_{ac}$  = Available Member Capacity for LL+IMP

**Structural Steel Section (SS)  
LFD  
Non-Composite, Unbraced Non-Compact Section Compression Flange  
Determine Analysis Case**

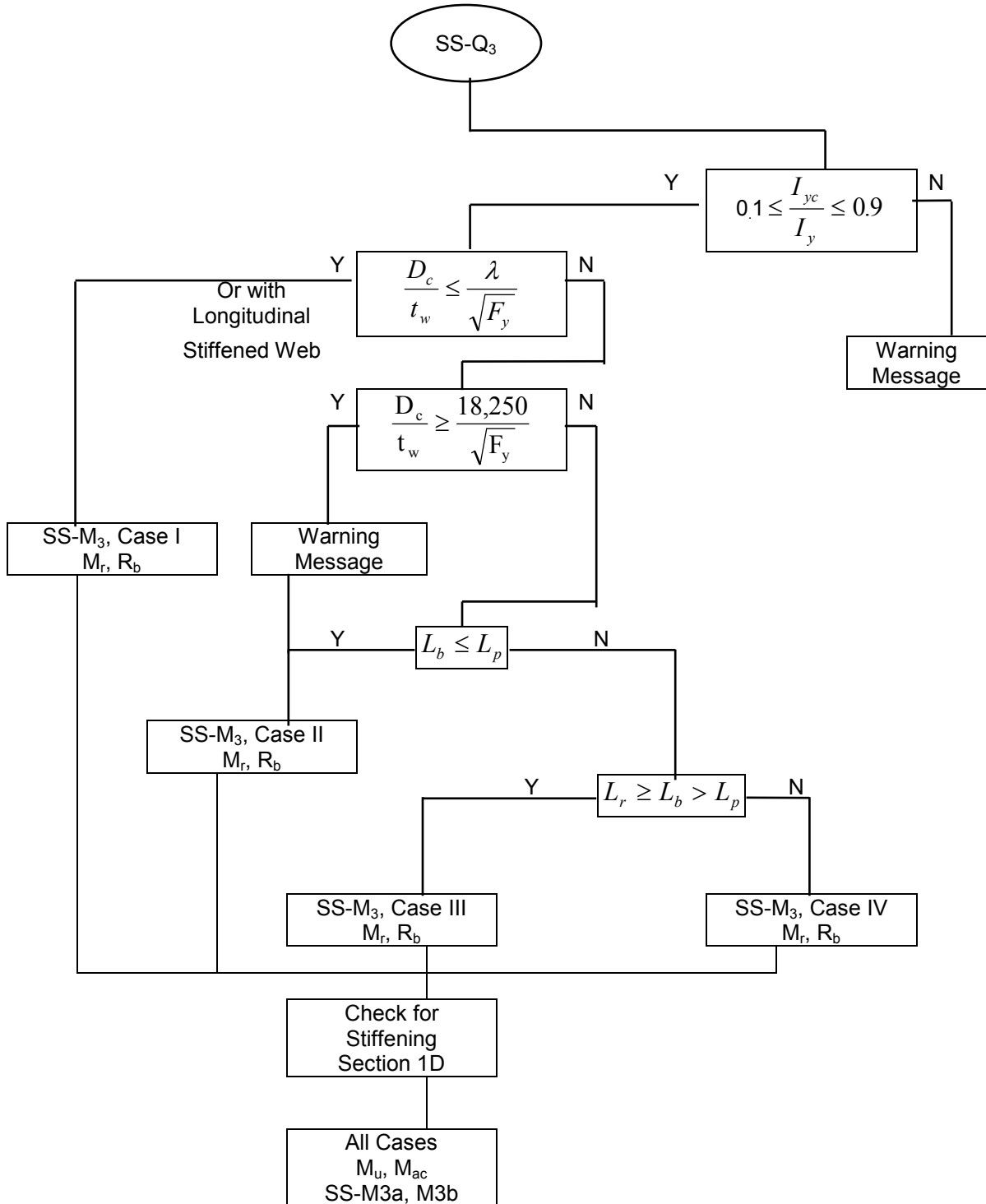

**Moment and Available Capacity Analysis - Structural Members**  
**LFD**

**Non-Composite, Compact - Moment Capacity for Compression Flange**

SS-M1a:

For non-composite, compact sections, the maximum moment strength at the section  $M_u$  is calculated as follows, in accordance with Bridge Specification 10.48.1:

$$M_u = F_y Z \quad (\text{i.e., } Z \text{ is the Plastic Section Modulus})$$

SS-M1b:

The available capacity for LL + IMP is calculated by the formulae as follows:

$$Cap_{Avail} = \left[ \frac{M_u}{1.3} \pm M_{dl} \pm M_{sdl} \right] [F] ,$$

where, for inventory:  $F = \frac{3}{5}$ , and

for operating and posting:  $F = 1.0$

**Non-Composite, Braced, Non-Compact - Moment Capacity for Compression Flange**

SS-M2a:

For non-composite, braced, non-compact section, the maximum moment strength at the section  $M_u$  is calculated as follows, in accordance with Bridge Specification 10.48.2:

$$M_u = F_y S$$

SS-M2b:

The available capacity for LL + IMP and moment capacity is calculated by the formulae as follows:

$$Cap_{AVAIL} = \left[ \frac{F_y}{1.3} \pm \frac{M_{dl}}{S} \pm \frac{M_{sdl}}{S} \right] S [F]$$

where, for inventory:  $F = \frac{3}{5}$ , and

for operating and posting:  $F = 1.0$

**Non-Composite, Unbraced, Non-Compact - Moment Capacity for Compression Flange and Available Capacity for LL + IMP**

SS-M3:

To establish the appropriate calculation method, a series of qualifications of the section will be made in the following manner.

A non-composite unbraced section is analyzed in accordance with Bridge Specification 10.48.4.1:

where  $\lambda = 15,400$  for all members with a compression flange area equal to or greater than the tension flange area.

$= 12,500$  for members with a compression flange area less than the tension flange area.

SS-M3, Case I

If  $\frac{D_c}{t_w} \leq \frac{\lambda}{\sqrt{F_y}}$  or with longitudinally stiffened web,

$$M_r = 91 \times 10^6 C_b \left( \frac{I_{yc}}{L_b} \right) \sqrt{0.772 \frac{J}{I_{yc}} + 9.87 \left[ \frac{d}{L_b} \right]^2} \leq M_y$$

where  $C_b = 1.75 + 1.05 \left( \frac{M_1}{M_2} \right) + 0.3 \left( \frac{M_1}{M_2} \right)^2, \leq 2.3,$

or  $C_b = 1.0$ , if moment within unbraced length  $\leq M_s$  (Note\*)

with  $M_1 =$  smaller moment

$M_2 =$  larger moment

$\frac{M_1}{M_2} = +$  where reverse curvature

$\frac{M_1}{M_2} = -$  where single curvature

and where 
$$J = \frac{[bt^3]_b + [bt^3]_t + [Dt_w^3]}{3}$$

Note \*: LARS may either compute the  $C_b$  value or use a  $C_b = 1$

SS-M3, Case II

$$\text{If } \frac{\lambda}{\sqrt{F_y}} < \left( \frac{D_c}{t_w} \right) \leq \frac{18,250}{\sqrt{F_y}}$$

and if  $L_b \leq L_p$ , where  $L_b$  is input as braced length

$$\text{and } L_p = \frac{9,500r'}{\sqrt{F_y}}$$

$$M_y = F_y S$$

$$M_r = M_y$$

SS-M3, Case III

$$\text{If } \frac{\lambda}{\sqrt{F_y}} < \left( \frac{D_c}{t_w} \right) \leq \frac{18,250}{\sqrt{F_y}}$$

and if  $L_r \geq L_b > L_p$ , where  $L_b$  is input as braced length

$$\text{where } L_r = \sqrt{\frac{572 \times 10^6 I_{yc} d}{F_y S_{xc}}} \text{ and } L_p = \frac{9,500r'}{\sqrt{F_y}}$$

$$M_r = C_b F_y S_{xc} \left[ 1 - 0.5 \left\{ \frac{L_b - L_p}{L_r - L_p} \right\} \right]$$

SS-M3, Case IV

$$\text{If } \frac{\lambda}{\sqrt{F_y}} < \left( \frac{D_c}{t_w} \right) \leq \frac{18,250}{\sqrt{F_y}}$$

and if  $L_b \geq L_r$ , where  $L_r = \sqrt{\frac{572 \times 10^6 I_{yc} d}{F_y S_{xc}}}$

$$M_r = C_b \frac{F_y S_{xc}}{2} \left( \frac{L_r}{L_b} \right)^2$$

### Non-Composite, Unbraced Non-Compact- Moment Capacity for Compression Flange

#### SS-M3a:

For non-composite, unbraced non-compact section, the maximum strength at the section  $M_u$  is calculated as follows, in accordance with Bridge Specification 10.48.4:

For longitudinally stiffened girders, with symmetrical sections having  $\frac{D}{t_w} \leq \frac{73,000}{\sqrt{F_y}}$ ,

for longitudinally stiffened girders, with unsymmetrical sections, having  $D_c > \frac{D}{2}$ , and

$$\frac{D_c}{t_w} \leq \frac{36,500}{F_y}$$

then  $R_b = 1.0$

Otherwise:

$$R_b = 1 - 0.002 \left[ \frac{D_c t_w}{A_{fc}} \right] \left[ \frac{D_c}{t_w} - \frac{\lambda}{\sqrt{M_r / S_{xc}}} \right] \leq 1.0$$

$$M_u = M_r R_b$$

#### SS-M3b:

The value of the available capacity for LL + IMP moment at the section is calculated as follows:

$$Cap_{Avail} = \left[ \frac{M_u}{1.3} \pm M_{dl} \pm M_{sdl} \right] [F] ,$$

where, for inventory:  $F = \frac{3}{5}$ , and

for operating and posting:  $F = 1.0$



**SECTION 1.2.2**

**COMPOSITE STRUCTURAL STEEL AND CONCRETE**

**LOAD FACTOR DESIGN METHODS**

**MOMENT ANALYSIS**

**FOR:**

- **COMPOSITE COMPACT SECTIONS**
- **BRACED, NON-COMPACT SECTIONS**

Composite Steel and Concrete Section (CSC)  
LFD  
Check of Composite Section

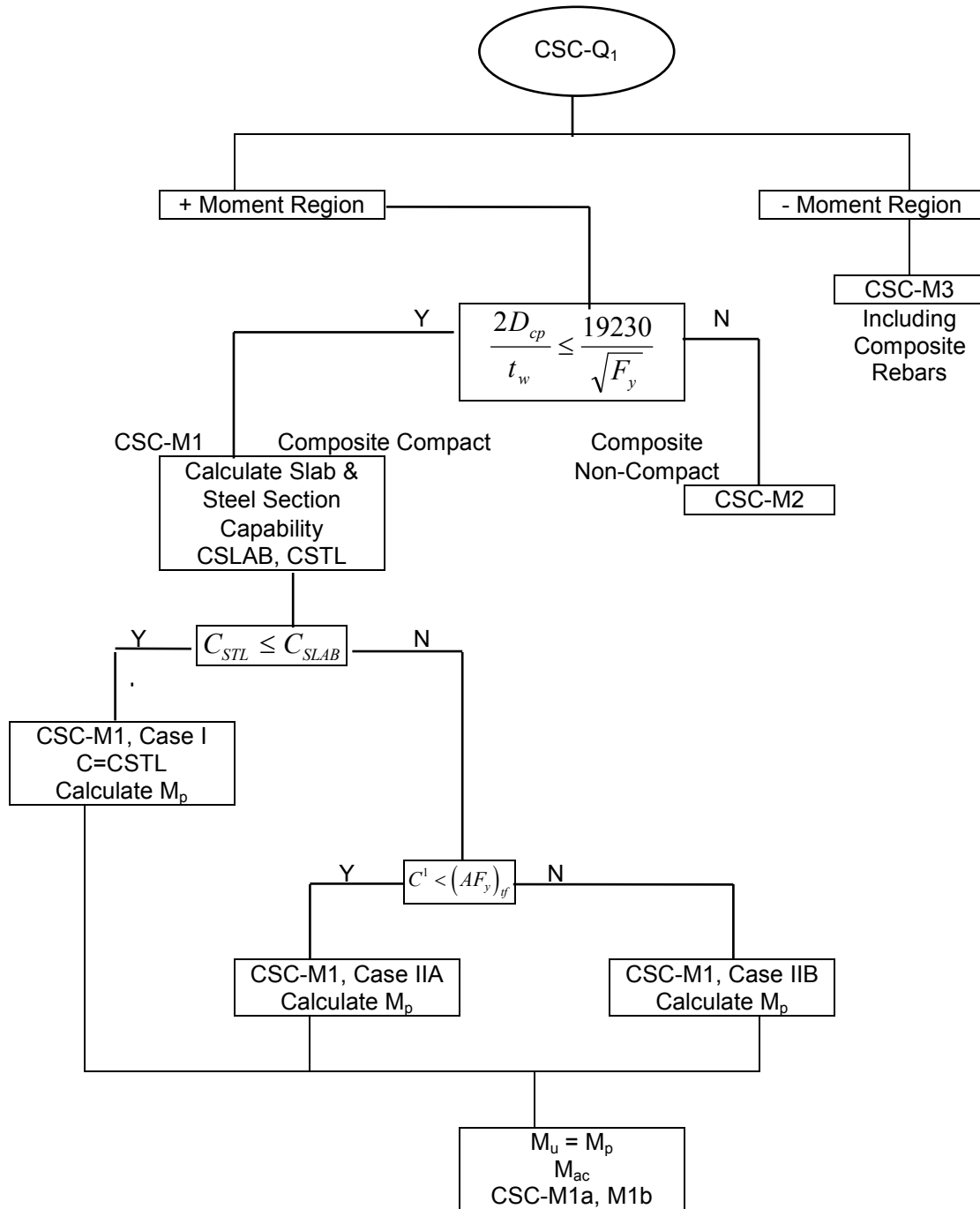

Note: The area of the slab steel is included in the resisting capacity of the steel or composite section when the steel is defined on input (i.e., RT 14), the CP is in the negative moment

area (i.e., within 0.3 of the span length either side of the interior supports of continuous members, and then only for positive bending analysis).

### Composite Steel and Concrete Members

#### CSC-Q1: Qualification for Compact Section of a Composite Member

The first step in the analysis of a composite member is to determine whether or not it is compact. The following analysis checks makes that determination, in accordance with Bridge Specification 10.50.1.1.2.

$$\text{Web thickness: } \frac{2D_{cp}}{t_w} \leq \frac{19,230}{\sqrt{F_y}}$$

When the base steel member section is determined to be compact by the qualifications described in CSC-Q1, Cases I, IIA and IIB, and the member is of composite construction, then the maximum moment strength is calculated by the formula of CSC-Q1, Cases I, IIA and IIB with the section tests and analysis methods described in the Bridge Specification Section 10.50.1.1.

### Composite, Compact - Moment Capacity

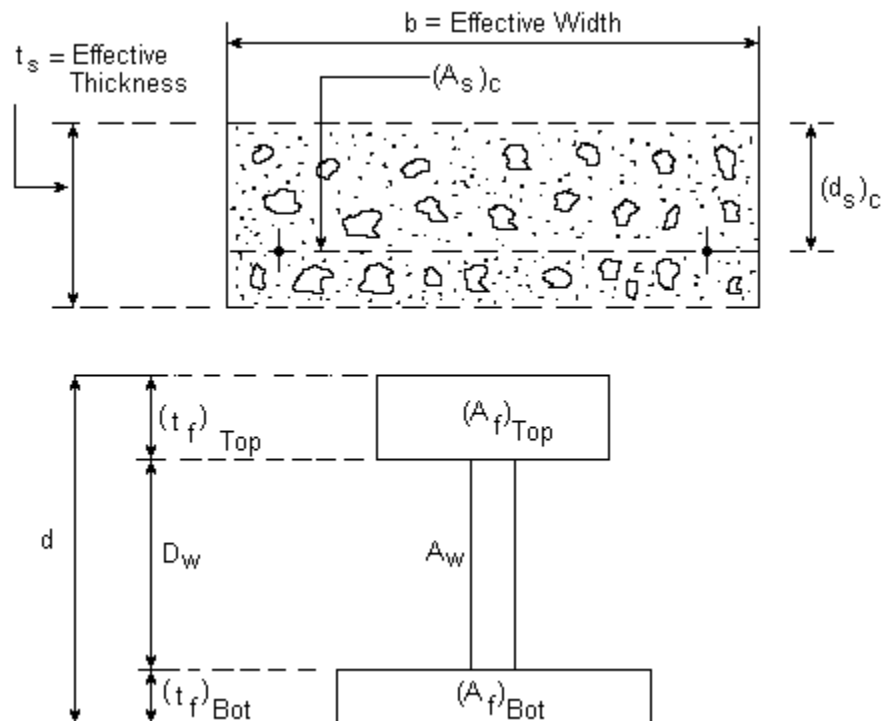

$$\text{Slab Capacity: } C_{SLAB} = 0.85f'_c(b)(t_s) + (A_s f_y)_c$$

Steel Section Capacity: 
$$C_{STL} = \left[ (AF_y)_{bf} + (AF_y)_{tf} + (AF_y)_w + (A(F_y))_{COVERPL} \right]$$

CSC-M1, Case I: Composite, Compact Section

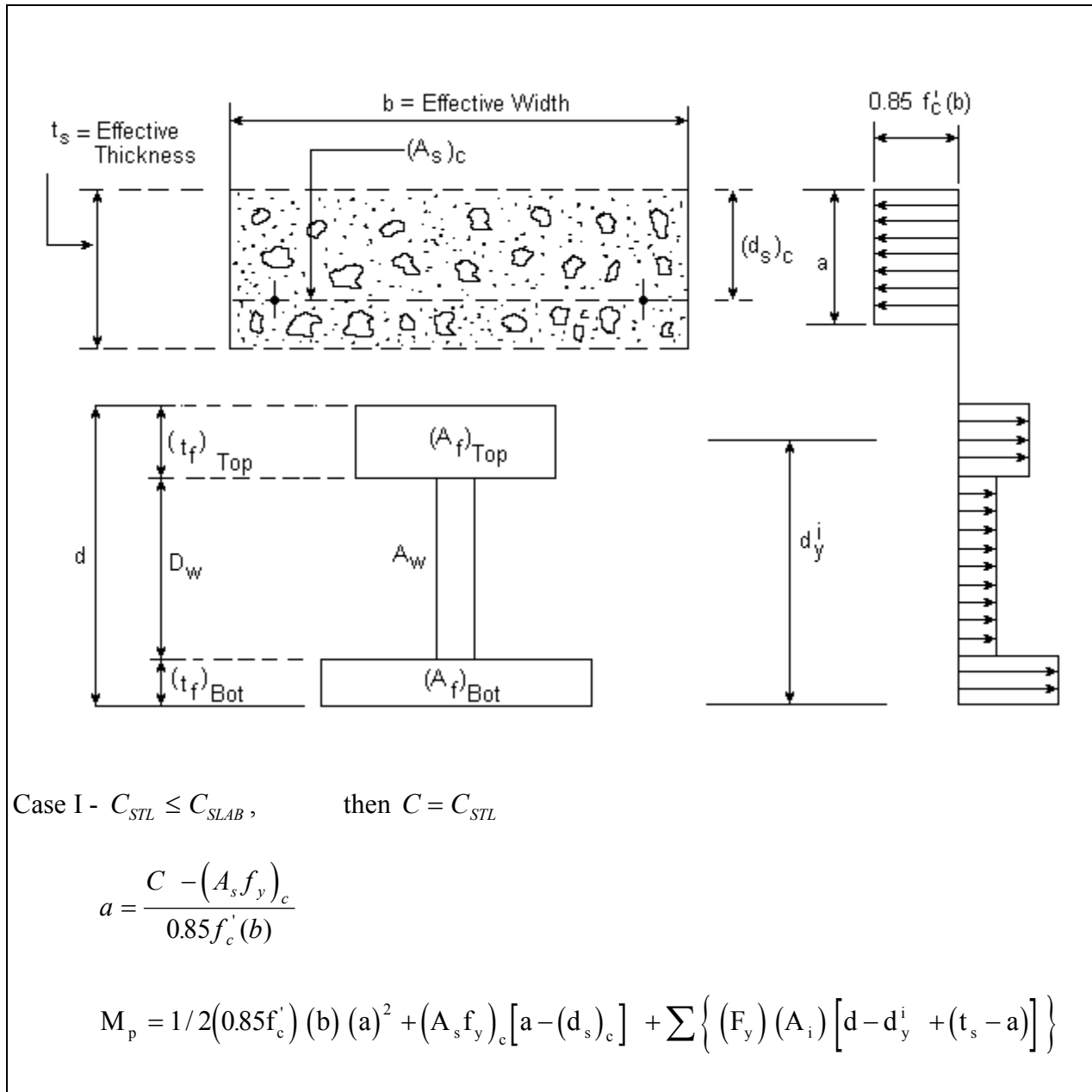

CSC-M1, Case IIA: Composite, Compact Section

The diagrams illustrate the geometry and stress distribution of a composite compact section. The top diagram shows a cross-section of the concrete slab with effective width  $b$  and effective thickness  $t_s$ . The area of steel reinforcement in the slab is  $(A_s)_c$ . The effective depth of the slab is  $(d_s)_c$ . The stress distribution in the slab is shown as a rectangular block with a maximum stress of  $0.85 f'_c(b)$ . The middle diagram shows the steel deck with top flange area  $(A_f)_{Top}$ , bottom flange area  $(A_f)_{Bot}$ , and web area  $A_w$ . The total depth of the steel deck is  $d$ , and the depth of the web is  $D_w$ . The top flange thickness is  $(t_f)_{Top}$  and the bottom flange thickness is  $(t_f)_{Bot}$ . The bottom diagram shows the stress distribution in the steel deck, with a maximum stress of  $d_y^i$ .

Case IIA  $C_{STL} > C_{SLAB}$  then  $C' = \frac{C_{STL} - C_{SLAB}}{2}$

and if  $C' < (A_f F_y)_{f'}$

then  $\bar{y} = \frac{C'}{(A_f F_y)_{f'}} (t)_{f'}$

$$M_p = 0.85f'_c(b) (t_s) \left( \frac{t_s}{2} + \bar{y} \right) + (A_s f_y)_c [t_s - (d_s)_c + \bar{y}] + \sum \{ (F_y) (A_i) [d - d_y^i - \bar{y}] \}$$

CSC-M1, Case IIB: Composite, Compact Section

The diagrams illustrate the geometry and stress distributions of a composite compact section. The top diagram shows a slab of effective thickness  $t_s$  and effective width  $b$ , with a concrete area  $(A_s)_c$ . The effective width  $b$  is defined as  $0.85 f'_c(b)$ . The slab is shown with a stress distribution of  $0.85 f'_c(b)$  across its thickness  $t$ . The bottom diagram shows a web of depth  $d$  and width  $A_w$ , with top and bottom flanges of thickness  $(t_f)_{Top}$  and  $(t_f)_{Bot}$  and area  $(A_f)_{Top}$  and  $(A_f)_{Bot}$ . The web is shown with a stress distribution  $\bar{y}$  across its depth  $d$ .

Case IIB  $C_{STL} > C_{SLAB}$  Then  $C' = \frac{C_{STL} - C_{SLAB}}{2}$

and if  $C' \geq (AF_y)_{tf}$

then  $\bar{y} = \frac{C' - (AF_y)_{tf}}{(AF_y)_w} (D_w) + (t)_{tf}$

and  $\frac{2D_{cp}}{t_w} \leq \frac{19,230}{\sqrt{F_y}}$ , where  $D_{cp} = \bar{y} - t_{tf}$

then

$$M_p = 0.85 f'_c(b) (t_s) \left( \frac{t_s}{2} + \bar{y} \right) + (A_s f_y)_c [t_s - (d_s)_c + \bar{y}] + C' \left( \frac{\bar{y}}{2} \right) + \sum \{ (F_y) (A_i) [d - d_y^i - \bar{y}] \}$$

## Composite, Compact - Moment Capacity

### CSC-M1a:

The maximum moment strength of a composite compact section is calculated as follows, in accordance with Bridge Specification 10.50.1.1.1 and 10.50.1.1.2:

if  $D_p \leq D'$

then  $M_u = M_p$

if  $D' < D_p \leq 5D'$

then 
$$M_u = \frac{5M_p - 0.85M_y}{4} + \frac{0.85M_y - M_p}{4} \left( \frac{D_p}{D'} \right)$$

where:

$$\frac{D_p}{D'} \leq 5$$

$$D' = \beta \frac{(d + t_s + t_h)}{7.5}$$

$\beta = 0.9$  for  $F_y = 36,000$  psi or  $0.70$  for  $50,000$  and  $70,000$  psi

$M_y$  = moment capacity at first yield of composite section

$$M_y = F_y S_{n=n(\text{tension\_flange})}$$

For continuous spans with compact composite moment section but with noncompact noncomposite or composite negative moment pier sections, the moment capacity may be computed as follows:

$$M_u = M_y + A(M_u - M_s)_{\text{pier}}$$

where:

$$M_y = \frac{M_{dl}}{S_x} + \frac{M_{sdl}}{S_{x(n=n)}} + \frac{M_{ll+i}}{S_{x(n=3n)}}$$

$A(M_u - M_s)_{\text{pier}} = M_u$  is the noncompact moment capacity of the pier section

from 10.48.4.2 or 10.48.4

$M_s$  is elastic moment at the pier for the load producing maximum positive bending in the span. For members with adjacent spans, use the smaller of the pier sections for interior spans

$A = 1$  for interior spans

= Distance from end support to the location of the maximum positive moment divided by the span length for end spans.



CSC-M1b:

The value of the available capacity for LL + IMP moment at the section is calculated as follows:

$$Cap_{Avail} = \left[ \frac{M_u}{1.3} \pm M_{dl} \pm M_{sdl} \right] [F] ,$$

where, for inventory:  $F = \frac{3}{5}$ , and

for operating and posting:  $F = 1.0$

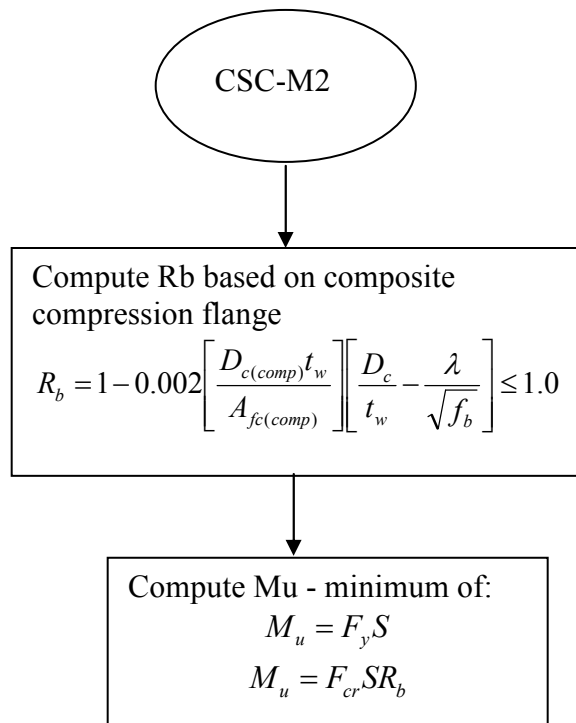

### Composite, Braced Non-Compact Section – Positive Moment Areas

If the base steel section of a composite member has been determined to be non-compact by the qualifications of CSC-Q2, then the moment capacity and available capacity for LL + IMP are calculated by the following formulae.

#### CSC-M2a:

For a composite, braced, non-compact section, the maximum moment strength at the section  $M_u$  is calculated as follows:

Compute  $R_b$  based on compression flange –

$$R_b = 1 - 0.002 \left[ \frac{D_{c(comp)} t_w}{A_{fc(comp)}} \right] \left[ \frac{D_c}{t_w} - \frac{\lambda}{\sqrt{f_b}} \right] \leq 1.0$$

Compute moment capacity based on  $F_{cr}$  and  $F_y$

$$M_u = F_y S$$

$$M_u = F_{cr} S R_b$$

Use minimum of the two above values for  $M_u$

#### CSC-M2b:

The value of the available moment capacity for LL + IMP at the section is calculated as follows:

$$CAP_{AVAIL} = \left[ \frac{M_u}{1.3} \pm \frac{M_{dl}}{S} \pm \frac{M_{sdl}}{S_{n=3n}} \right] (S_{n=n}) [F]$$

where, for inventory:  $F = \frac{3}{5}$ , and

for operating and posting:  $F = 1.0$

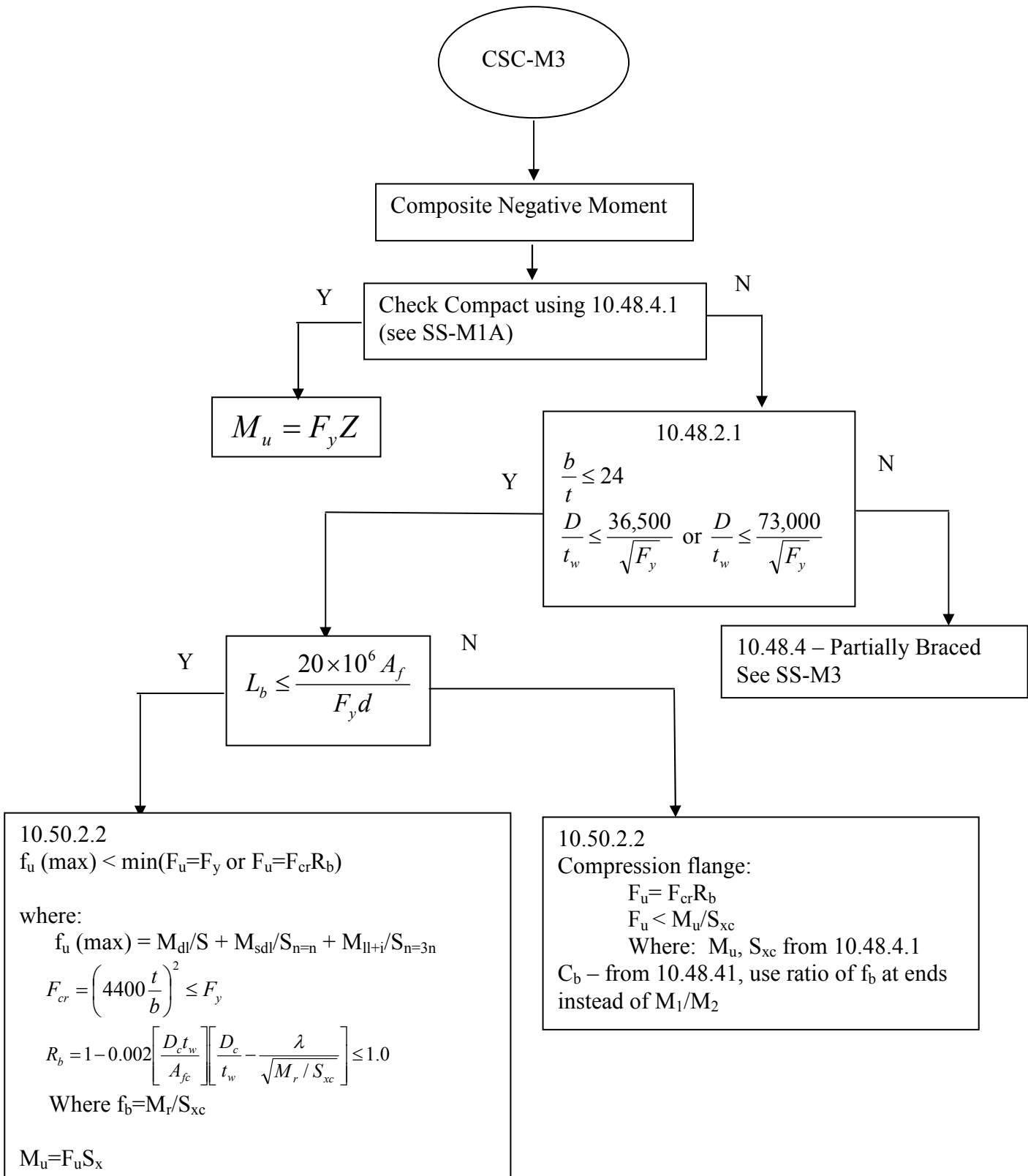

### Composite, Braced Non-Compact Section – Negative Moment Areas

If the base steel section of a composite member has been determined to be non-compact by the qualifications of CSC-Q3, then the moment capacity and available capacity for LL + IMP are calculated by the following formulae.

#### CSC-M3a:

For a composite, braced, non-compact section, the maximum moment strength at the section  $M_u$  is calculated as follows:

Evaluate compactness based on 10.48.4.1 – see SS-M1

$$M_u = F_y Z$$

Evaluate braced non-compact criteria based on 10.48.2.1 – if the flange and web criteria are met:

$$M_u = F_u S$$

Where:

$$f_u (\text{max}) < \min(F_u = f_b \text{ or } F_u = F_{cr} R_b)$$

$$F_{cr} = \left( 4400 \frac{t}{b} \right)^2 \leq F_y$$

$$R_b = 1 - 0.002 \left[ \frac{D_c t_w}{A_{fc}} \right] \left[ \frac{D_c}{t_w} - \frac{\lambda}{\sqrt{M_r / S_{xc}}} \right] \leq 1.0$$

$$f_b = \frac{M_r}{S_{xc}}$$

$M_r$  calculated from 10.48.4

#### CSC-M3b:

The value of the available moment capacity for LL + IMP at the section is calculated as follows:

$$CAP_{AVAIL} = \left[ \frac{M_u}{1.3} \pm \frac{M_{dl}}{S} \pm \frac{M_{sdl}}{S_{n=3n}} \right] (S_{n=n}) [F]$$

where, for inventory:  $F = \frac{3}{5}$ , and

for operating and posting:  $F = 1.0$

**SECTION 1.2.3**

**STRUCTURAL STEEL**

**AND**

**COMPOSITE STEEL AND CONCRETE**

**LOAD FACTOR DESIGN METHOD**

**MOMENT ANALYSIS**

**FOR:**

- **HYBRID GIRDERS**

**Structural Steel (SS)/Composite Steel and Concrete (CSC)**

**LFD**  
**Hybrid Girders**

Specification	Reduction Factor	Page
10.53.1.1	Non-Composite - Compact	63
10.53.1.2	Non-Composite - Braced Non-Compact	64
10.53.1.3	Non-Composite - Unbraced Non-Compact	65
10.53.2	Composite - Braced Non-Compact	66

**Structural Steel (SS)/Composite Steel and Concrete (CSC)**  
**LFD**  
**Moment Analysis Method for SS/CSC Hybrid Member**

The following are descriptions of the methods used by LARS to perform LFD member moment analysis when the structural steel/composite steel and concrete member section is of a hybrid nature (i.e., the strength in the web is lower than one or both of the flanges), and qualifies as a **non-composite compact** section. The moment capacity is calculated by the formula in MH-2a, and the available capacity is calculated by the formula in MH-2b.

MH-2a:

For a SS/CSC hybrid member of non-composite compact section, the maximum moment strength at the section *Hyb*  $M_u$  is calculated as follows, in accordance with Bridge Specification 10.53.1.1:

$$R_{LC} = (F_{yf}) / F_y$$

$$\text{Hyb } M_u = R_{LC}(M_u)$$

Note: For hybrid girder, revise  $(t_w)Hyb = t_w \left[ \frac{F_{yw}}{F_{yf} (MIN)} \right]$

For value of  $M_u$  = Moment Capacity, refer to Moment Analysis.

MH-2b:

For a SS/CSC hybrid member of a non-composite compact section, the value of the available capacity for LL + IMP moment at the section is calculated as follows:

$$CAP_{AVAIL} = \left[ \frac{HybM_u}{1.3} \pm M_{dll} \pm M_{sdll} \right] [F]$$

where for inventory:  $[F] = \frac{3}{5}$ , and

for operating and posting:  $[F] = 1.0$

**Structural Steel (SS)/Composite Steel and Concrete (CSC)  
LFD  
Moment Analysis Method for SS/CSC Hybrid Member**

The following are descriptions of the methods used by LARS to perform LFD member moment analysis when the structural steel/composite steel and concrete member section is of a hybrid nature (i.e., the strength in the web is lower than one or both of the flanges), and qualifies as a **non-composite braced non-compact** section. The moment capacity is calculated by the formula in MH-3a, and the available capacity is calculated by the formula in MN-3b.

MH-3a:

For a SS/CSC hybrid member of a non-composite braced non-compact section, the maximum moment strength at the section *Hyb M<sub>u</sub>* is calculated as follows, in accordance with Bridge Specification 10.53.1.2:

$$R = 1 - \left[ \frac{\beta\phi(1-\rho)^2(3-\phi+\rho\phi)}{6 + \beta\phi(3-\phi)} \right]$$

$$\text{Hyb } M_u = R(F_{yf} / F_y)(M_u)$$

Note: For hybrid girder, revise  $(t_w)_{Hyb} = t_w \left[ \frac{F_{yw}}{F_{yf} (MIN)} \right]$

For value of  $M_u$  = Ultimate Moment Capacity, refer to Moment Analysis.

MH-3b:

The value of the available capacity for LL + IMP moment at the section is calculated as follows:

$$CAP_{AVAIL} = \left[ \frac{HybM_u}{1.3} \pm M_{dl} \pm M_{sdl} \right] [F]$$

where for inventory:  $[F] = \frac{3}{5}$ , and

for operating and posting:  $[F] = 1.0$



**Structural Steel (SS)/Composite Steel and Concrete (CSC)  
LFD  
Moment Analysis Method for SS/CSC Hybrid Member**

The following are descriptions of the methods used by LARS to perform LFD member moment analysis when the structural steel/composite steel and concrete member section is of a hybrid nature (i.e., the strength in the web is lower than one or both of the flanges), and qualifies as a **non-composite unbraced non-compact** member. The moment capacity is calculated by the formula in MH-4a, and the available capacity is calculated by the formula in MH-4b.

MH-4a:

For a SS/CSC hybrid member of a non-composite unbraced non-compact section, the maximum moment strength at the section *Hyb M<sub>u</sub>* is calculated as follows, in accordance with Bridge Specification 10.53.1.3:

$$R = 1 - \left[ \frac{\beta\phi(1-\rho)^2(3-\phi+\rho\phi)}{6 + \beta\phi(3-\phi)} \right]$$

$$\text{Hyb } M_u = R M_u$$

Note: For hybrid girder, revise  $(t_w)_{Hyb} = t_w \left[ \frac{F_{yw}}{F_{yf} (MIN)} \right]$

For value of  $M_u$  = Ultimate Moment Capacity, see Moment Analysis.

MH-4b:

The value of the available capacity for LL + IMP moment at the section is calculated as follows:

$$CAP_{AVAIL} = \left[ \frac{HybM_u}{1.3} \pm M_{dl} \pm M_{sdl} \right] [F]$$

where for inventory:  $[F] = \frac{3}{5}$ , and

for operating and posting:  $[F] = 1.0$

**Structural Steel (SS)/Composite Steel and Concrete (CSC)  
LFD  
Moment Analysis Method for SS/CSC Hybrid Member**

The following are descriptions of the methods used by LARS to perform LFD member moment analysis when the composite steel and concrete member section is of a hybrid nature (i.e., the strength of the web is longer than one or both of the flanges), and qualifies as a **composite braced non-compact** section. The moment capacity is calculated by the formula in MH-5a, and the available capacity is calculated by the formula in MH-5b.

MH-5a:

For a CSC hybrid member of a composite braced non-compact section, the maximum moment strength at the section  $Hyb M_u$  is calculated as follows, in accordance with Bridge Specification 10.53.2:

$$R = 1 - \left[ \frac{\beta\phi(1-\rho)^2(3-\phi+\rho\phi)}{6 + \beta\phi(3-\phi)} \right]$$

$$Hyb M_u = HybCAP_{AVAIL} \pm M_{dl} \pm M_{sdl}$$

MH-5b:

The value of the available capacity for LL + IMP moment at the section is calculated as follows:

$$HybCAP_{AVAIL} = \left[ \frac{F_y R}{1.3} \pm \frac{M_{dl}}{S} \pm \frac{M_{sdl}}{S_n = 3n} \right] (S_{n=n}) [F]$$

where for inventory:  $[F] = \frac{3}{5}$ , and

for operating and posting:  $[F] = 1.0$

**SECTION 1.2.4**

**STRUCTURAL STEEL**

**AND**

**COMPOSITE STEEL AND CONCRETE**

**LOAD FACTOR DESIGN METHOD**

**SHEAR ANALYSIS**

**Structural Steel (SS)/Composite Steel and Concrete (CSC)**  
**LFD**

Specification	Value of c		
10.48.8.1	If $\frac{D_w}{t_w} < \frac{6000\sqrt{k}}{\sqrt{F_y}}$ , $c = 1.0$ $k = 5 + \frac{5}{\left(\frac{d_o}{D_w}\right)^2}$		
	If $\frac{6000\sqrt{k}}{\sqrt{F_y}} \leq \frac{D_w}{t_w} \leq \frac{7500\sqrt{k}}{\sqrt{F_y}}$ , $c = \frac{6000\sqrt{k}}{\left(\frac{D_w}{t_w}\right)\sqrt{F_y}}$		
	If $\frac{D_w}{t_w} > \frac{7500\sqrt{k}}{\sqrt{F_y}}$ , $c = \frac{4.5(10)^7 k}{\left(\frac{D_w}{t_w}\right)^2 F_y}$		
	Transverse Stiffener	Web Condition	Page
10.48.8.1	N	Unstiffened Web	68
10.48.8.1	Y	Stiffened Web Check $(d_o/D) \leq 3$	69

**Structural Steel (SS)/Composite Steel and Concrete (CSC)**  
**LFD**  
**Shear Analysis Method for SS/CSC Member**

The following are descriptions of the methods for LARS to perform LFD shear analysis when the member web is **unstiffened**. The shear capacity is calculated by the formula in VS-1a, and the available capacity is calculated by the formula in VS-1b.

VS-1a:

For a SS/CSC member with web unstiffened, the maximum shear strength at the section  $V_u$  calculated as follows, in accordance with Bridge Specification 10.48.8.1:

$$V_p = 0.58 F_y (D_w) (t_w)$$

$$V_u = c V_p , \text{ for value of } c, \text{ see page 68.}$$

VS-1b:

The value of the available capacity for LL + IMP shear at the section is calculated as follows:

$$V_{AVAIL} = \left[ \left( \frac{V_u}{1.3} \right) \pm V_{DL} \pm V_{SDL} \right] [F]$$

where for inventory:  $F = \frac{3}{5}$  , and

for operating and posting:  $F = 1.0$

**Structural Steel (SS)/Composite Steel and Concrete (CSC)**  
**LFD**  
**Shear Analysis Method for SS/CSC Member**

The following are descriptions of the methods for LARS to perform LFD shear analysis when the member web is **stiffened**. The shear capacity is calculated by the formula in VS-2a, and the available capacity is calculated by the formula in VS-2b.

Note: Check  $(d_0/D) > 3$ . If true, issue a warning message.

VS-2a:

For a SS/CSC member with stiffened web, the maximum shear strength at the section  $V_u$  is calculated as follows, in accordance with Bridge Specification 10.48.8.1:

$$V_p = 0.58F_y(D_w)(t_w)$$

$$V_u = V_p \left[ c + \frac{0.87(1-c)}{\sqrt{1 + \left(\frac{d_0}{D}\right)^2}} \right], \text{ for value of } c, \text{ see page 68.}$$

VS-2b:

The value of the available capacity for LL + IMP shear at the section is calculated as follows:

$$V_{AVAIL} = \left[ \left( \frac{V_u}{1.3} \right) \pm V_{DL} \pm V_{SDL} \right] [F]$$

where for inventory:  $F = \frac{3}{5}$ , and

for operating and posting:  $F = 1.0$

**SECTION 1.2.5**

**STRUCTURAL STEEL**

**AND**

**COMPOSITE STEEL AND CONCRETE**

**LOAD FACTOR DESIGN METHOD**

**FOR**

**MOMENT - SHEAR INTERACTION**

**Structural Steel (SS)/Composite Steel and Concrete (CSC)  
LFD  
Moment - Shear Interaction Analysis**

Specification	Moment - Shear Interaction	Page
10.48.8.2	$M > 0.75 M_u$	72

$$M = M_{dl} + M_{sdl} + M_{LL+IMP}$$



**Structural Steel (SS)/Composite Steel and Concrete (CSC)**  
**LFD**  
**Moment Shear Interaction Analysis Method for SS/CSC Member**

The following are descriptions of the methods for LARS to perform LFD moment shear interaction analysis when the structural steel/composite steel and concrete member is simultaneously subjected to shear and bending moment such that  $M > 0.75 M_u$ . The shear capacity is calculated by the formula in MV-1a, and the available capacity is calculated by the formula in MV-1b.

MV-1a:

For a SS/CSC member with  $M > 0.75 M_u$ , the maximum shear strength at the section  $MV_{CAP}$  is calculated as follows, in accordance with Bridge Specification 10.48.8.2:

$$MV_{CAP} = V_u \left[ 2.2 - 1.6 \left( \frac{M}{M_u} \right) \right]$$

For value of  $V_u$ , refer to Shear Analysis.

MV-1b:

The value of the available capacity for LL + IMP shear at the section is calculated as follows:

$$CAP_{AVAIL} = \left[ \frac{MV_{CAP}}{1.3} \pm V_{dl} \pm V_{sdl} \right] [F]$$

where for inventory:  $F = \frac{3}{5}$ , and

for operating and posting:  $F = 1.0$

**SECTION 1.2.6**

**STRUCTURAL STEEL**

**AND**

**COMPOSITE STEEL AND CONCRETE**

**LOAD FACTOR DESIGN METHODS**

**FOR**

**STIFFENER REQUIREMENTS**

**Structural Steel (SS)/Composite Steel and Concrete (CSC)**  
**LFD**  
**Stiffener Requirement**

Specification	$D_w/t_w$	Requirements
10.48.8.3	$\leq 150$	No stiffener required
10.48.5.1	$\frac{36500}{\sqrt{F_y}} < \frac{D_w}{t_w} \leq \frac{73000}{\sqrt{F_y}}$	Transverse stiffeners required No longitudinal stiffener required
10.48.6.1	$\frac{73000}{\sqrt{F_y}} < \frac{D_w}{t_w}$	Transverse and longitudinal stiffeners required
10.49.2 (Unsymmetrical Section)	$\frac{18250}{\sqrt{F_y}} < \left(\frac{D_c}{t_w}\right) < \frac{36500}{\sqrt{F_y}}$ when $D_c > \left(\frac{D_w}{2}\right)$	Transverse stiffeners required
10.49.3.2	$\frac{36500}{\sqrt{F_y}} < \frac{D_c}{t_w}$ when $D_c > \left(\frac{D_w}{2}\right)$	Transverse and longitudinal stiffeners required

**SECTION 1.2.7**

**STRUCTURAL STEEL**

**AND**

**COMPOSITE STEEL AND CONCRETE**

**LOAD FACTOR DESIGN METHOD**

**FOR**

**SERVICEABILITY MOMENT ANALYSIS**

**Structural Steel (SS)/Composite Steel and Concrete (CSC)**  
**LFD**  
**Serviceability Moment Analysis**

Specification	Member	Page
10.57.1*	Non-Composite Structural Steel (SS)	77
10.57.2*	Composite Steel and Concrete (CSC)	78

\* Also see Manual for Condition Evaluation of Bridges, 6.6.3.1.

**Non-Composite Structural Steel (SS)**  
**LFD**  
**Serviceability Analysis Method for Structural Steel Members**

The following are descriptions of the methods used by LARS to perform LFD member serviceability analysis when the structural steel member section is of **non-composite construction**. The serviceability capacity is calculated by the formula in SMS-1a, and the available capacity is calculated by the formula in SMS-1b.

SMS-1a:

For a structural steel member of non-composite construction, the maximum serviceability strength at the section  $SM_{CAP}$  is calculated as follows, in accordance with Bridge Specification 10.57.1:

$$SERV \ CAP = (0.8F_y)(S_x)$$

SMS-1b:

The value of the available serviceability capacity for LL + IMP movement at the section is calculated as follows:

$$CAP_{AVAIL} = \left[ SERV \ CAP \pm M_{dl} \pm M_{sdl} \right] [F]$$

where for inventory:  $[F] = \frac{3}{5}$ , and

for operating and posting:  $[F] = 1.0$

**Composite Structural Steel and Concrete (CSC)  
LFD  
Serviceability Analysis Method for Composite Structural Steel Member**

The following are descriptions of the methods used by LARS to perform LFD member serviceability analysis when the composite structural steel member section is of **composite construction**. The serviceability capacity is calculated by the formula in SMC-1a, and the available capacity is calculate by the formula in SMC-1b.

SMC-1a:

For a composite structural steel member of composite construction, the maximum serviceability strength at the section  $SM_{CAP}$  is calculated as follows, in accordance with Bridge Specification 10.57.2:

$$SERV\ CAP = CAP_{AVAIL} \pm M_{dl} \pm M_{sdl}$$

SMC-1b:

The value of the available serviceability capacity for LL + IMP moment at the section is calculated as follows:

$$CAP_{AVAIL} = \left[ 0.95F_y \pm \frac{M_{dl}}{S} \pm \frac{M_{sdl}}{S_{(n=3n)}} \right] S_{(n=n)} [F]$$

where for inventory:  $[F] = \frac{3}{5}$ , and

for operating and rating:  $[F] = 1.0$

**SECTION 1.3.2**

**COMPOSITE STRUCTURAL STEEL AND CONCRETE**

**LOAD RESISTANCE FACTOR DESIGN METHODS**

**STRENGTH LIMIT STATE ANALYSIS**

**FOR:**

- **COMPOSITE COMPACT SECTIONS**
- **NONCOMPACT SECTIONS**



**Composite Steel and Concrete Section (CSC)  
LRFD  
Check of Composite Compact Section**

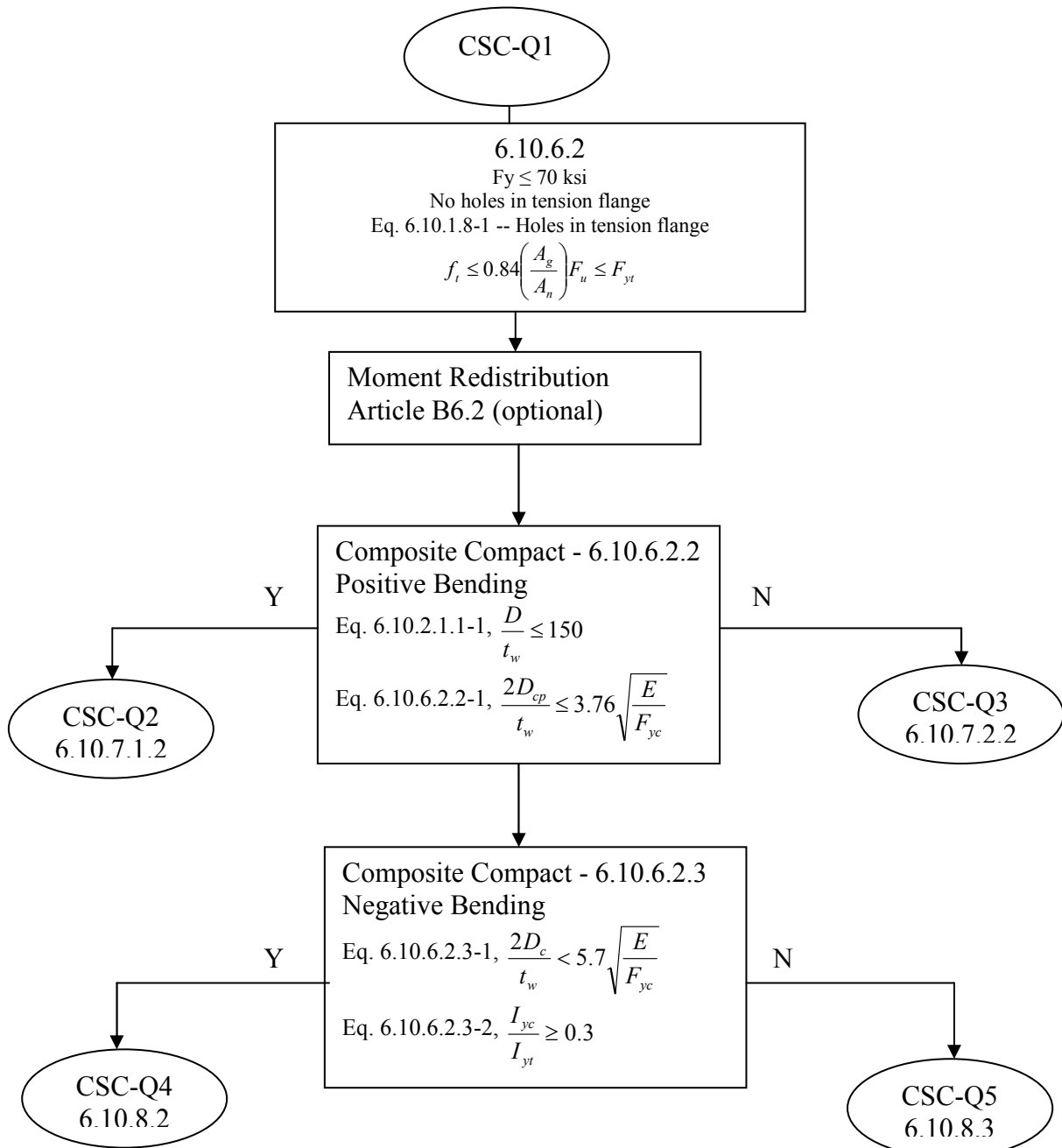

Composite Steel and Concrete Section (CSC)  
LRFD  
CSC Compact Positive Flexure

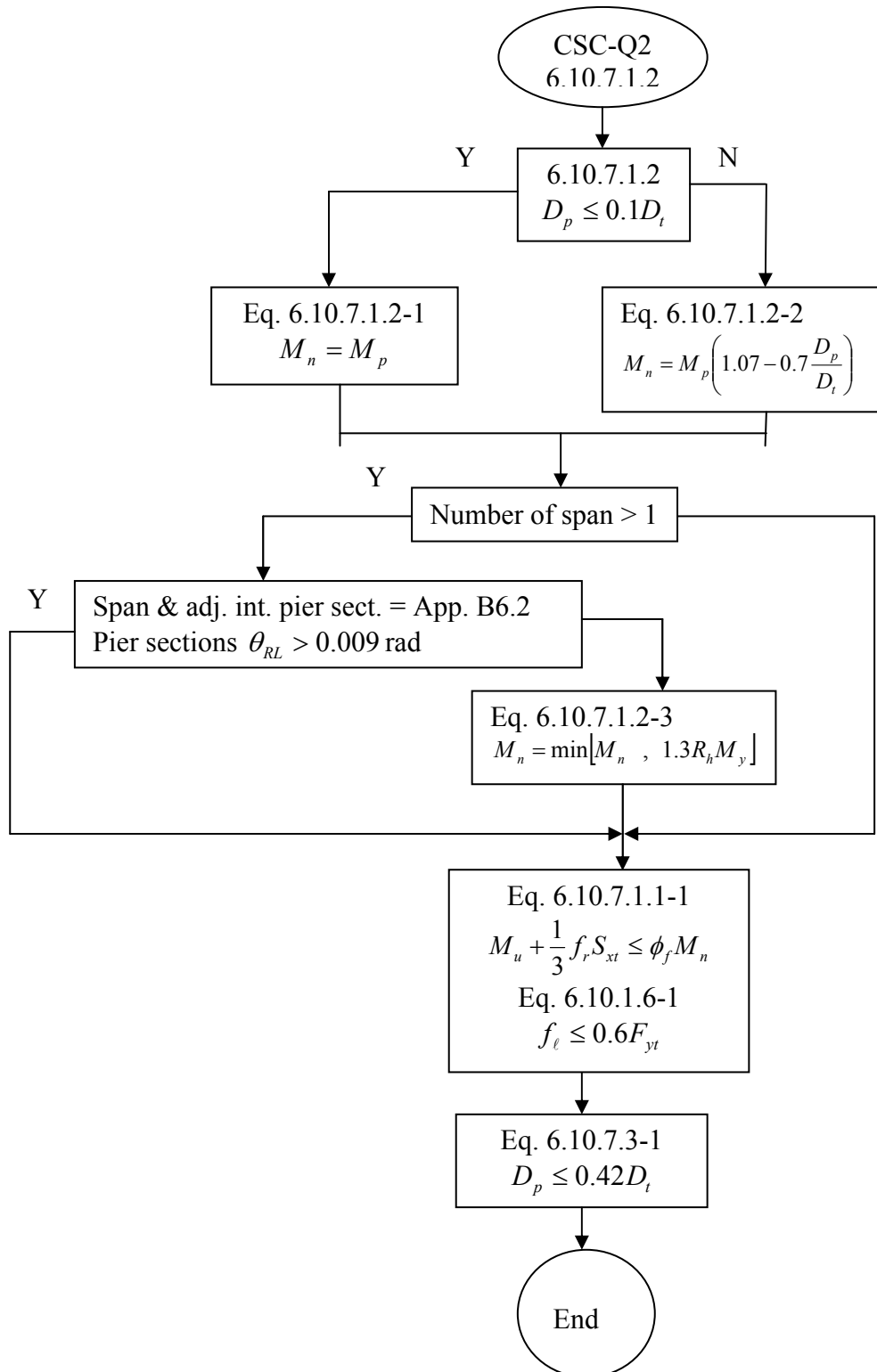

Composite Steel and Concrete Section (CSC)  
LRFD  
CSC Noncompact Positive Flexure

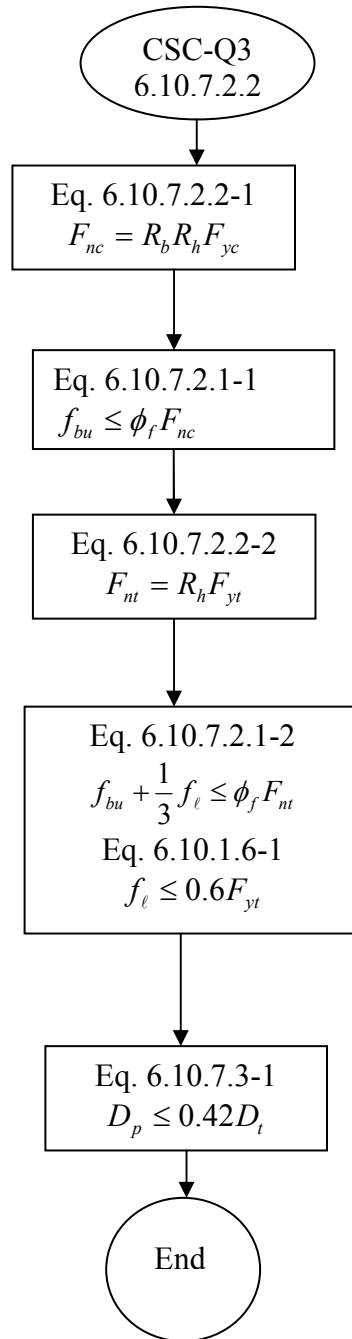

Composite Steel and Concrete Section (CSC)  
LRFD  
CSC Compact Negative Flexure

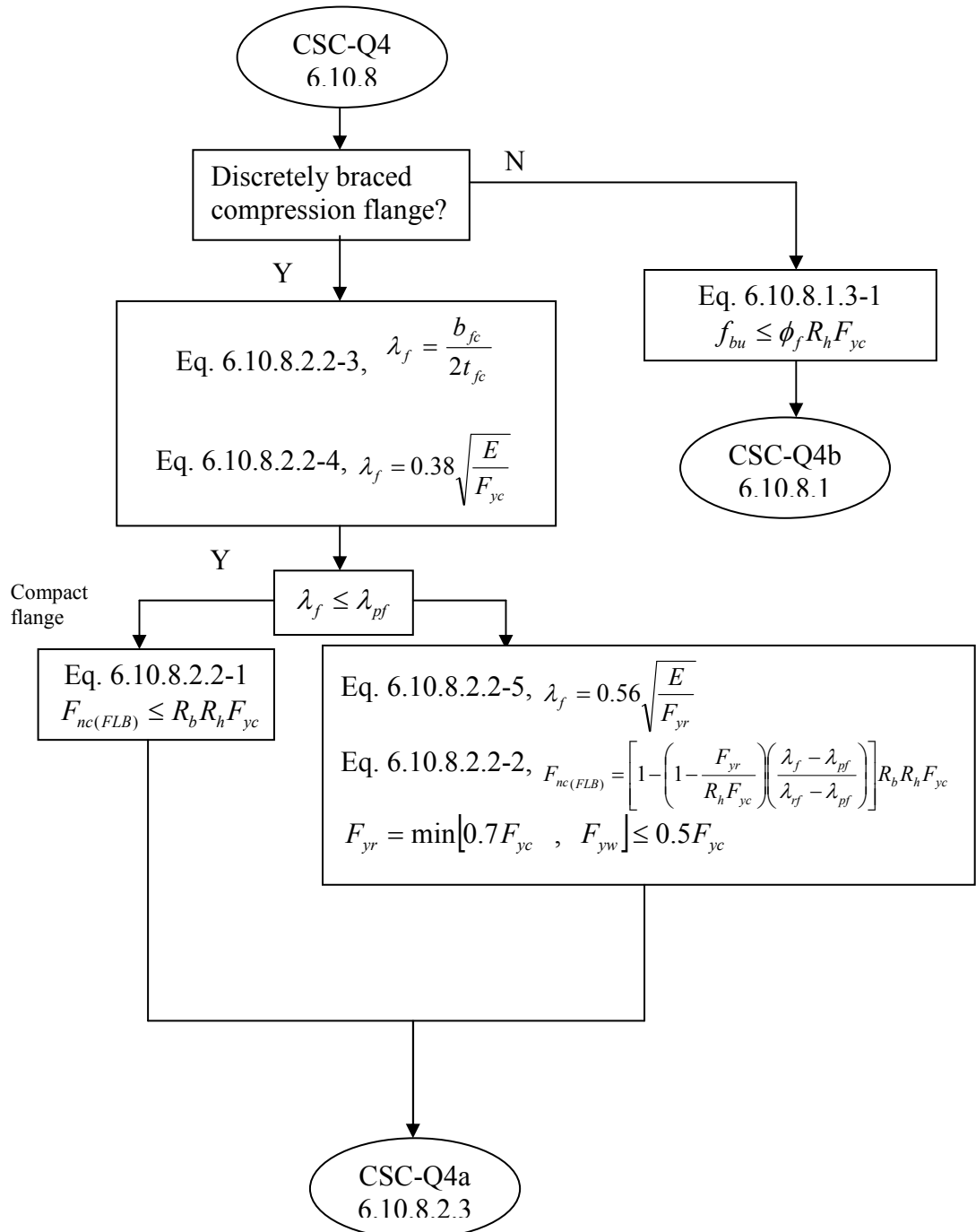

Composite Steel and Concrete Section (CSC)  
LRFD  
CSC Compact Negative Flexure cont.

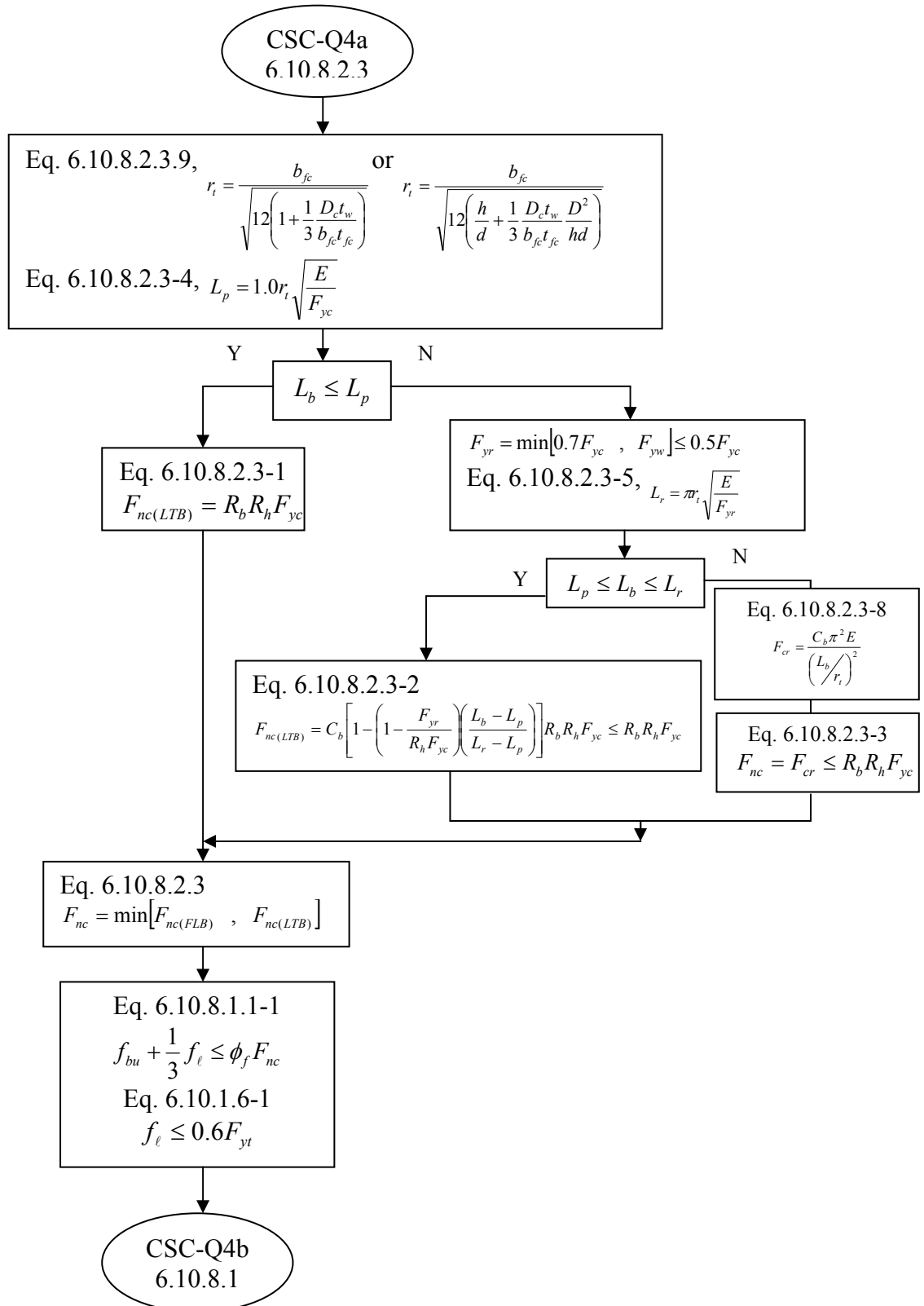

Composite Steel and Concrete Section (CSC)  
LRFD  
CSC Compact Negative Flexure cont.

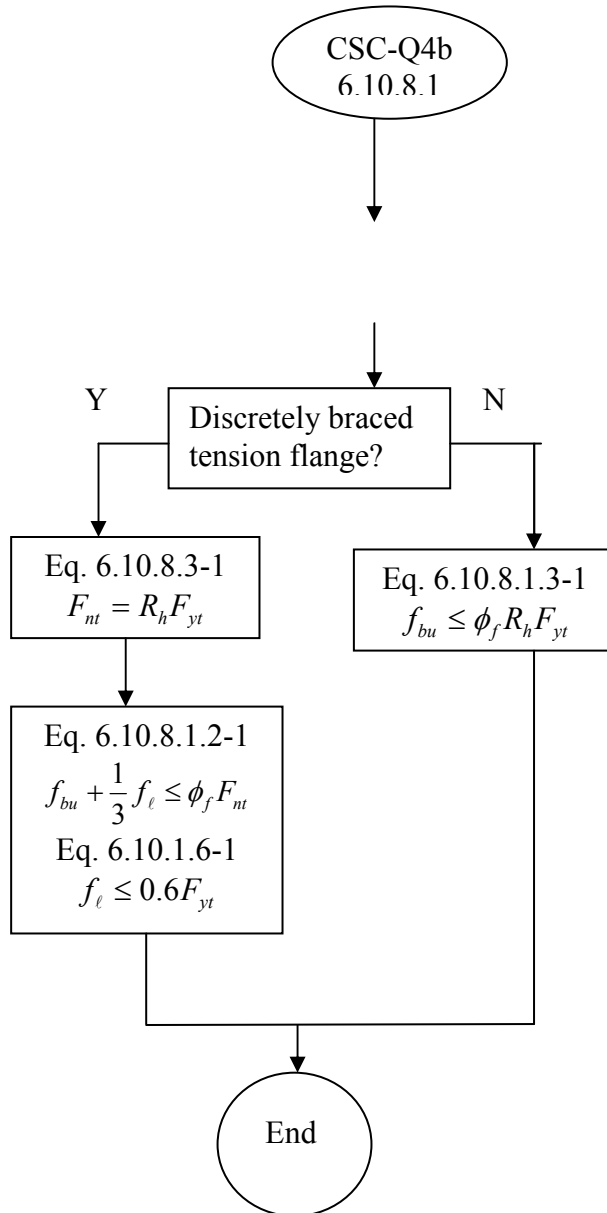

Note: The area of the slab steel is included in the resisting capacity of the steel or composite section when the steel is defined on input (i.e., RT 14), the CP is in the negative moment area (i.e., within 0.3 of the span length either side of the interior supports of continuous members, and then only for positive bending analysis).

Composite Steel and Concrete Section (CSC)  
LRFD  
CSC Compact Negative Flexure - Appendix A

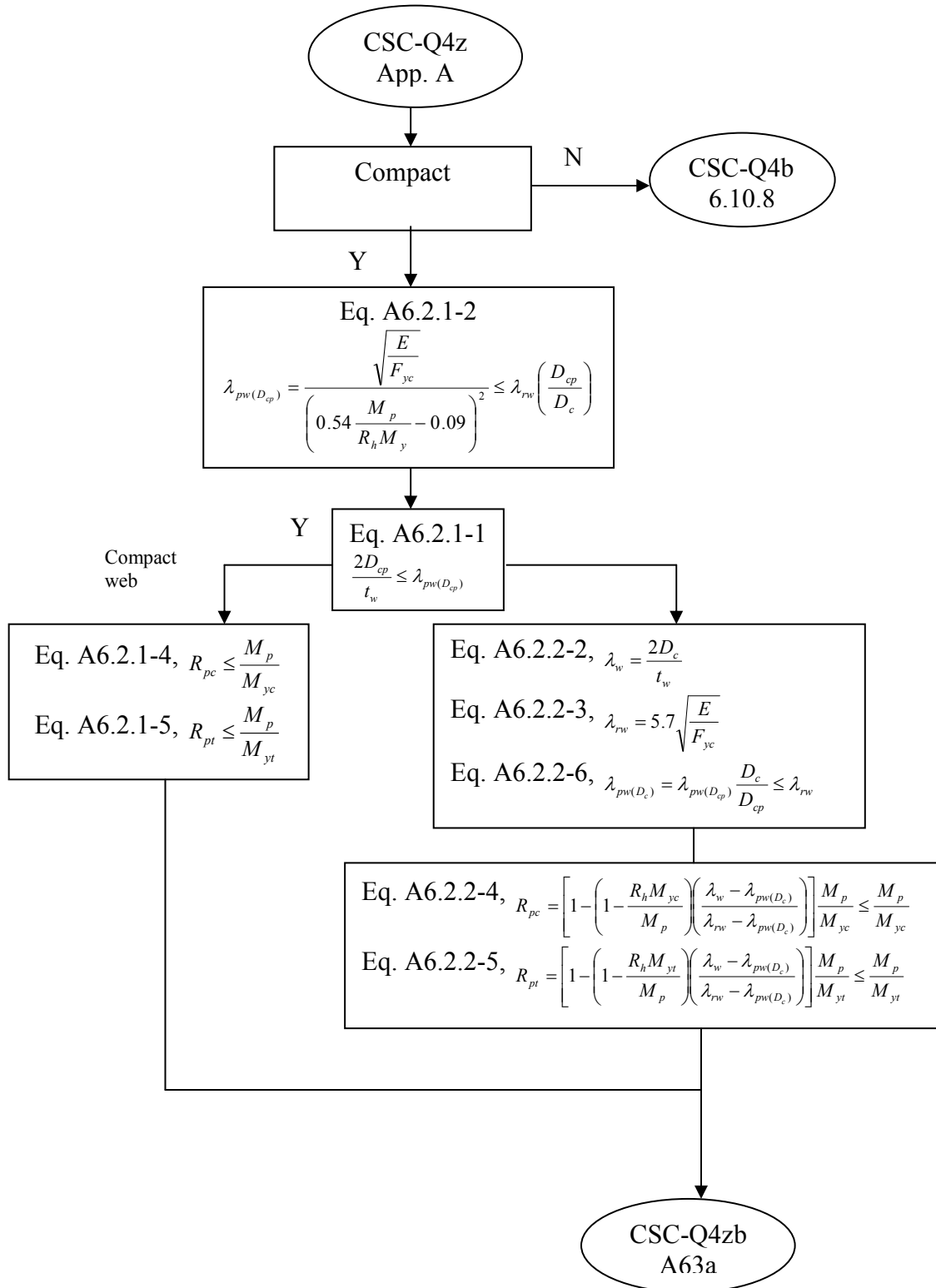



Composite Steel and Concrete Section (CSC)  
LRFD  
CSC Compact Negative Flexure Appendix A cont.

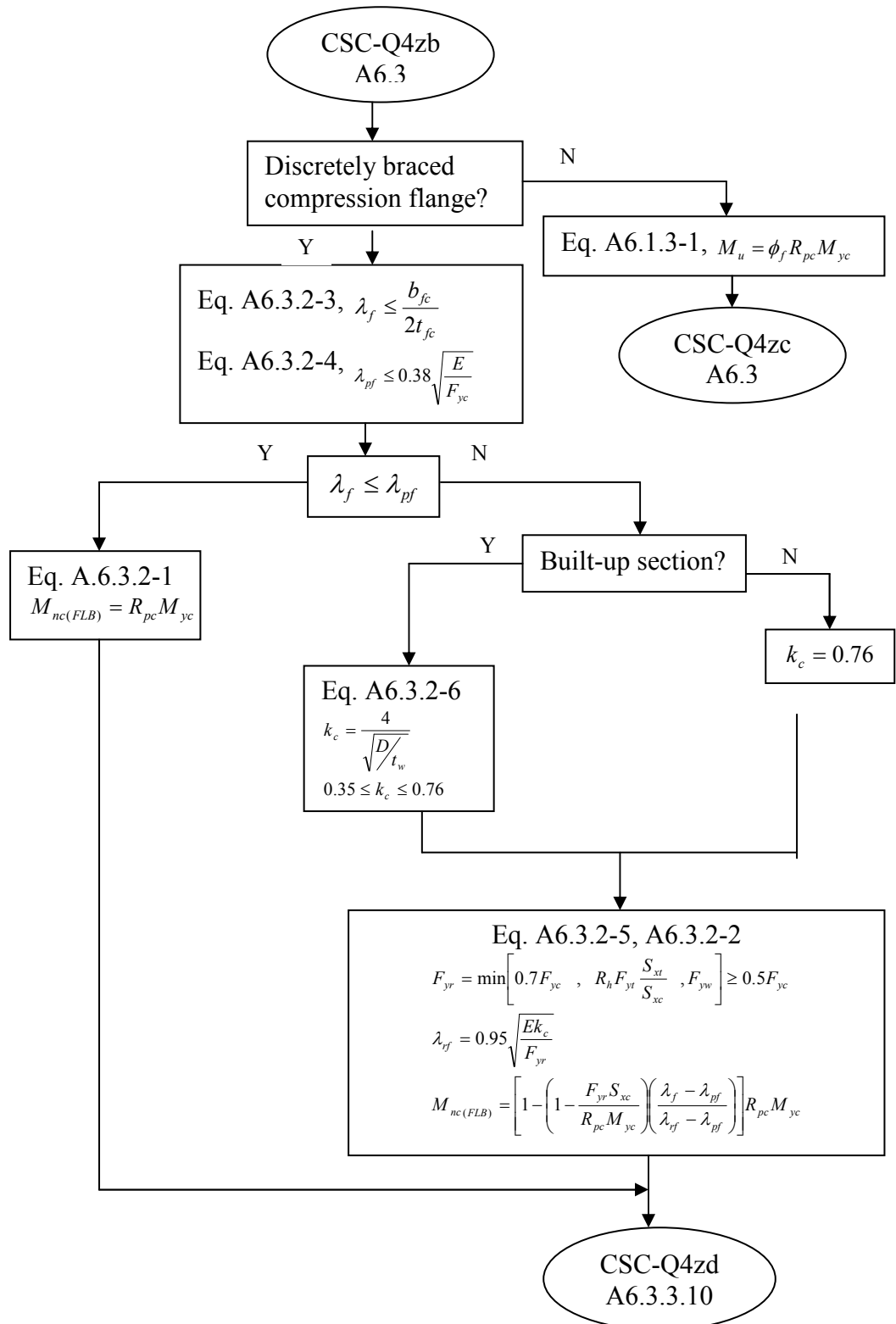

Composite Steel and Concrete Section (CSC)  
LRFD  
CSC Compact Negative Flexure Appendix A cont.

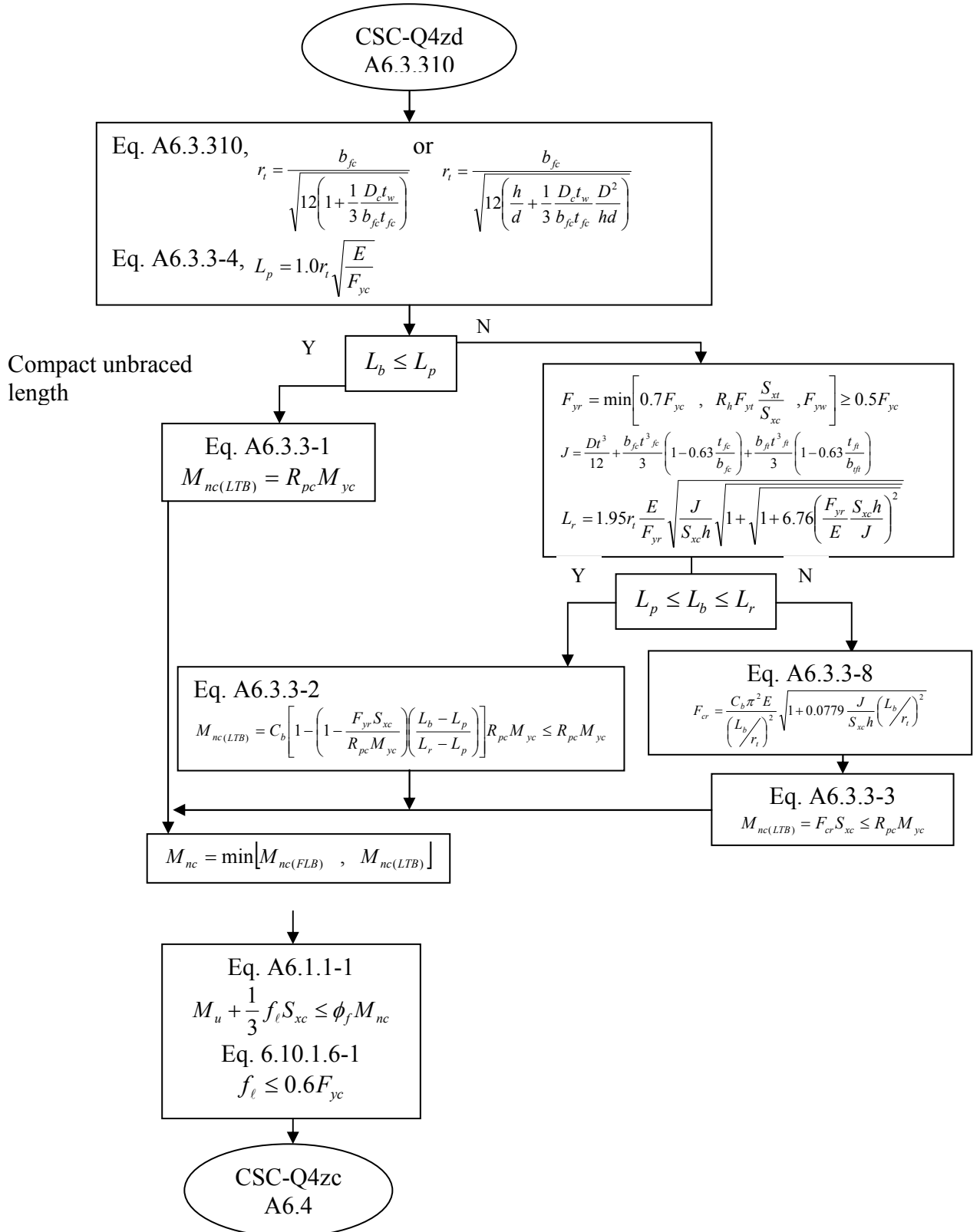

Composite Steel and Concrete Section (CSC)  
LRFD  
CSC Compact Negative Flexure Appendix A cont.

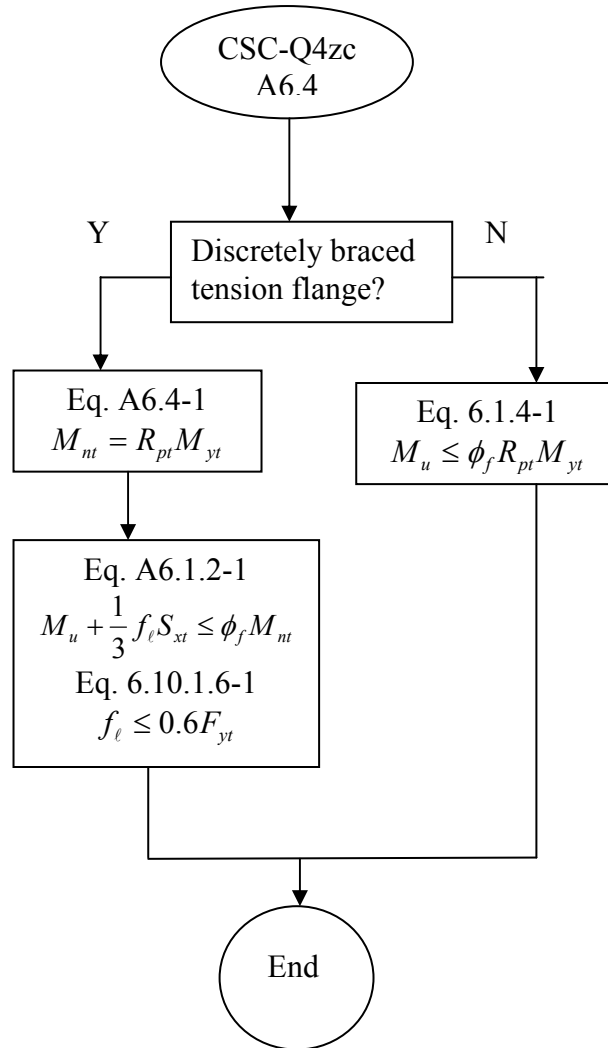

### Composite Steel and Concrete Members – 6.10.4.1.4

#### CSC-Q2a: Qualification for Compact Section of a Composite Member (+moment)

The first step in the analysis of a composite member is to determine whether or not it is compact. The following analysis checks that determination, in accordance with Bridge Specification 6.10.4.1.2.

$$\text{Web slenderness: } \frac{2D_{cp}}{t_w} \leq 3.76 \sqrt{\frac{E}{F_{yc}}}$$

#### CSC-M2a:

The maximum positive moment strength of a composite compact section is calculated as follows, in accordance with Bridge Specification 6.10.4.2.2:

$$M_r = \phi_f M_n$$

where:

if  $D_p \leq D'$  then  $M_n = M_p$  See Appendix A6.1 Plastic Moment

if  $D_p > D'$  and  $D' < D_p \leq 5D'$  then

$$M_n = \frac{5M_p - 0.85M_y}{4} + \frac{0.85M_y - M_p}{4} \left( \frac{D_p}{D'} \right)$$

if  $D_p > D'$  and  $D_p > 5D'$  then

$$M_n = 1.3R_h M_y \text{ or } M_n = R_h M_y + A[M_{np} - M_{cp}]$$

$$\phi_f = 1.00$$

#### CSC-M2b:

The value of the available capacity for LL + IMP moment at the section is calculated as follows:

$$CAP_{AVAIL} = [M_r \pm (F_1 \times M_{dl}) \pm (F_2 \times M_{sdl})]$$

where:

	F1	F2	F3
Service State	DL - DC	DL – wearing surface	LL
Strength I	$\gamma_p$	$\gamma_p$	1.75
Strength II	$\gamma_p$	$\gamma_p$	1.35
Service I	1.0	1.0	1.0

NOTE:  $\gamma_p = 1.25-0.9$  for DC

$\gamma_p = 1.50-0.65$  for w.s.

### Composite, Compact – Negative Moment Capacity 6.10.4.1.4

CSC-Q2b: Qualification for Compact Section of a Composite Member (-moment)

The first step in the analysis of a composite member is to determine whether or not it is compact. The following analysis checks that determination, in accordance with Bridge Specification 6.10.4.1.2, 6.10.4.1.3, 6.10.4.1.6 and 6.10.4.1.7

$$\begin{aligned} \text{Web slenderness:} & \quad \frac{2D_{cp}}{t_w} \leq 3.76 \sqrt{\frac{E}{F_{yc}}} \\ \text{Compression flange slenderness:} & \quad \frac{b_f}{2t_f} \leq 0.382 \sqrt{\frac{E}{F_{yc}}} \\ \text{Moment and shear interaction:} & \quad \frac{2D_{cp}}{t_w} \leq 0.75(3.76) \sqrt{\frac{E}{F_{yc}}} \text{ or } \frac{b_f}{2t_f} \leq 0.75(0.382) \sqrt{\frac{E}{F_{yc}}} \\ \text{And} & \quad \frac{2D_{cp}}{t_w} + 9.35 \left( \frac{b_f}{2t_f} \right) \leq 6.25 \sqrt{\frac{E}{F_{yc}}} \\ \text{Compression flange bracing:} & \quad Lb \leq \left[ 0.124 - 0.0759 \left( \frac{M_t}{M_p} \right) \right] \left[ \frac{r_y E}{F_{yc}} \right] \end{aligned}$$

CSC-M2c:

The maximum positive moment strength of a composite compact section is calculated as follows, in accordance with Bridge Specification 6.10.5.2:

$$M_r = \phi_f M_n$$

where:

if  $D_p \leq D'$  then  $M_n = M_p$  See Appendix A6.1 Plastic Moment

if  $D_p > D'$  and  $D' < D_p \leq 5D'$  then

$$M_n = \frac{5M_p - 0.85M_y}{4} + \frac{0.85M_y - M_p}{4} \left( \frac{D_p}{D'} \right)$$

if  $D_p > D'$  and  $D_p > 5D'$  then

$$M_n = 1.3R_h M_y \text{ or } M_n = R_h M_y + A [M_{np} - M_{cp}]$$

$$\phi_f = 1.00$$

CSC-M2d:

The value of the available capacity for LL + IMP moment at the section is calculated as follows:

$$CAP_{AVAIL} = [M_r \pm (F_1 \times M_{dl}) \pm (F_2 \times M_{sdl})]$$

where:

	F1	F2	F3
Service State	DL - DC	DL – wearing surface	LL
Strength I	$\gamma_p$	$\gamma_p$	1.75
Strength II	$\gamma_p$	$\gamma_p$	1.35
Service I	1.0	1.0	1.0

NOTE:  $\gamma_p = 1.25-0.9$  for DC  
 $\gamma_p = 1.50-0.65$  for w.s.

### Composite, Noncompact Section 6.10.4.1.4

If the base steel section of a composite member has been determined to be noncompact by the qualifications of CSC-Q3 then the moment capacity and available capacity for LL + IMP are calculated by the following formulae.

#### CSC-Q3a:

6.10.4.1.4 compression flange slenderness  $\frac{b_f}{2t_f} \leq 12.0$

6.10.4.1.9 Compression flange bracing  $L_b \leq L_p = 1.76r_t \sqrt{\frac{E}{F_{yc}}}$

6.10.4.2.4a Noncompact compression flange flexural resistance  $F_n = R_b R_h F_{cr}$

where:

without longitudinal stiffeners  $F_{cr} = \frac{1.904E}{\left(\frac{b_f}{2t_f}\right)^2 \sqrt{\frac{2D_c}{t_w}}} \leq F_{yc}$

with longitudinal stiffeners  $F_{cr} = \frac{0.166E}{\left(\frac{b_f}{2t_f}\right)^2} \leq F_{yc}$

6.10.4.2.4b Noncompact tension flange flexural resistance  $F_n = R_b R_h F_{yt}$

#### CSC-Q3b:

6.10.4.1.9 Compression flange bracing  $L_b > L_p = 1.76r_t \sqrt{\frac{E}{F_{yc}}}$

6.10.4.2.5a Noncompact composite flange flexural resistance based upon lateral torsional buckling

$$L_b \leq L_r = 4.44r_t \sqrt{\frac{E}{F_{yc}}}$$

compression flange  $F_n = C_b R_b R_h F_{yc} \left[ 1.33 - .187 \left( \frac{L_b}{r_t} \right) \right] \sqrt{\frac{F_{yc}}{E}} \leq R_b R_h F_{yc}$

$$L_b > L_r = 4.44r_t \sqrt{\frac{E}{F_{yc}}}$$

compression flange  $F_n = C_b R_b R_h \left[ \frac{9.86E}{\left(\frac{L_b}{r_t}\right)^2} \right] \leq R_b R_h F_{yc}$

6.10.4.2.5b Noncompact tension flange flexural resistance  $F_n = R_b R_h F_{yt}$

CSC-M3a:

For a composite, braced, noncompact section, the maximum positive moment strength at the section  $M_r$  is calculated as follows:

$$M_r = \phi_f F_n A_g$$

CSC-M3b:

The value of the available capacity for LL + IMP moment at the section is calculated as follows:

$$CAP_{AVAIL} = [M_r \pm (F_1 \times M_{dl}) \pm (F_2 \times M_{sdl})]$$

where:

	F1	F2	F3
Service State	DL - DC	DL – wearing surface	LL
Strength I	$\gamma_p$	$\gamma_p$	1.75
Strength II	$\gamma_p$	$\gamma_p$	1.35
Service I	1.0	1.0	1.0

NOTE:  $\gamma_p = 1.25-0.9$  for DC  
 $\gamma_p = 1.50-0.65$  for w.s.



**SECTION 1.3**  
**STRUCTURAL STEEL**  
**AND**  
**COMPOSITE STEEL AND CONCRETE**  
**LOAD RESISTANCE AND FACTOR DESIGN METHOD**



**SECTION 1.3.2**

**COMPOSITE STRUCTURAL STEEL AND CONCRETE**

**LOAD RESISTANCE FACTOR DESIGN METHODS**

**STRENGTH LIMIT STATE ANALYSIS**

**FOR:**

- **COMPOSITE COMPACT SECTIONS**
- **COMPOSITE NONCOMPACT SECTIONS**

Composite Steel and Concrete Section (CSC)  
LRFD  
Check of Composite Compact Section

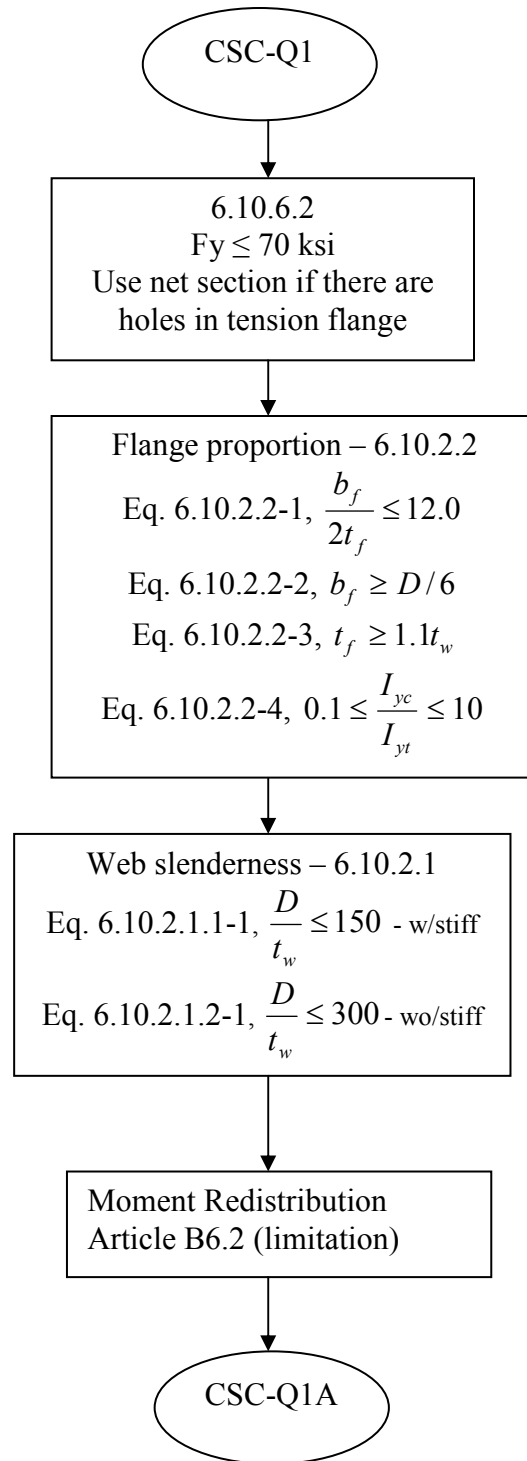

Composite Steel and Concrete Section (CSC)  
LRFD  
Check of Composite Compact Section

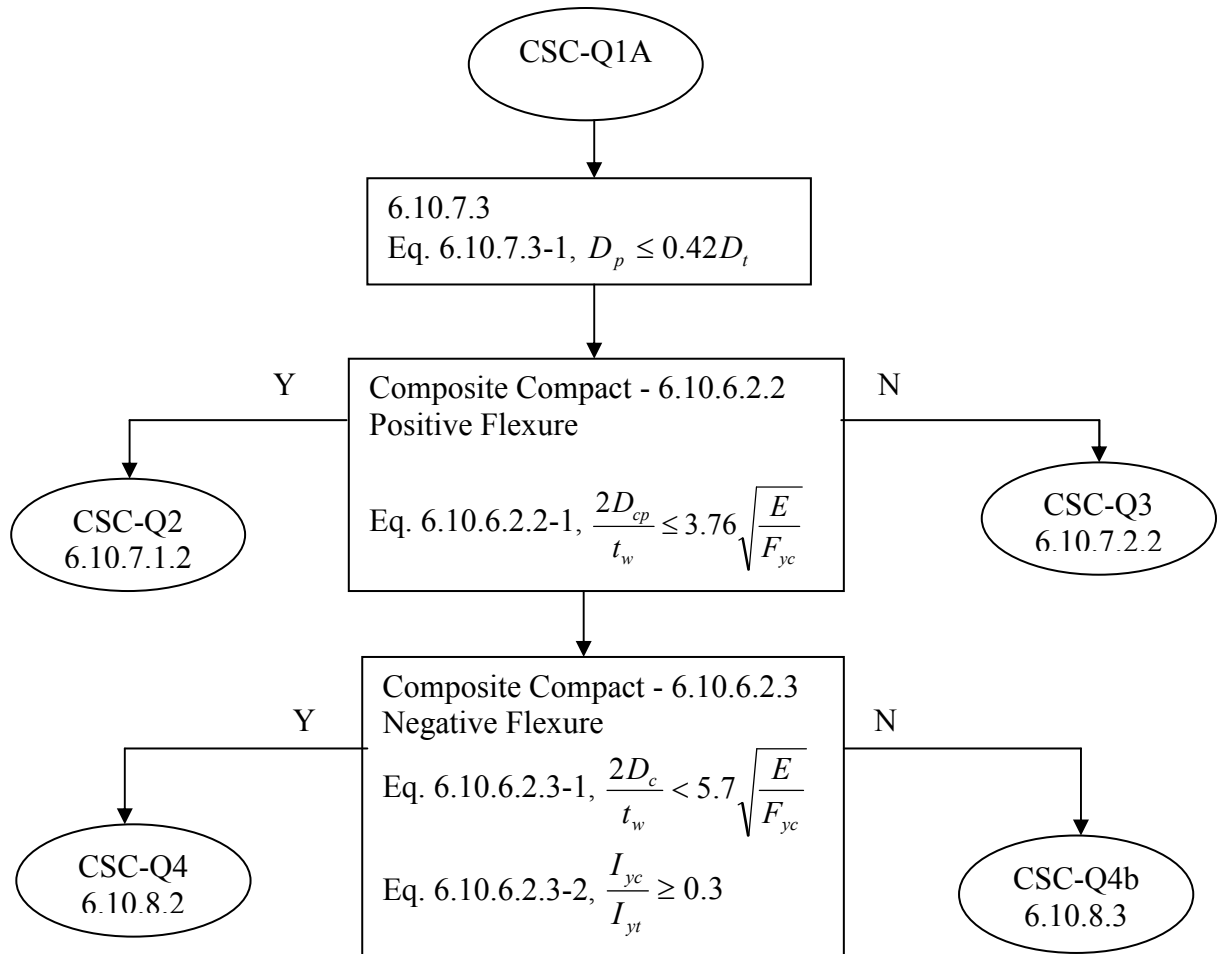

Composite Steel and Concrete Section (CSC)  
LRFD  
CSC Compact Positive Flexure

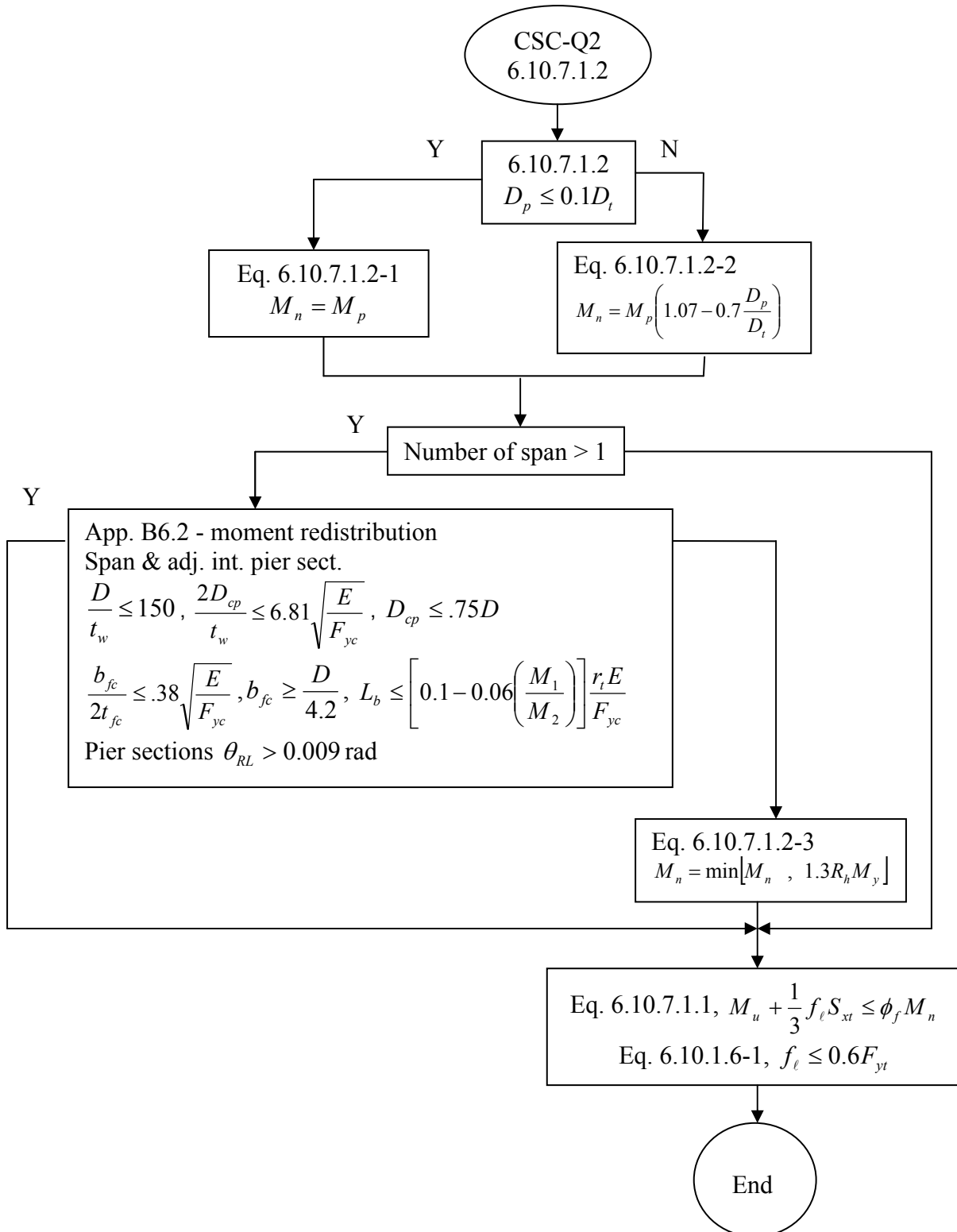

Composite Steel and Concrete Section (CSC)  
LRFD  
CSC Noncompact Positive Flexure

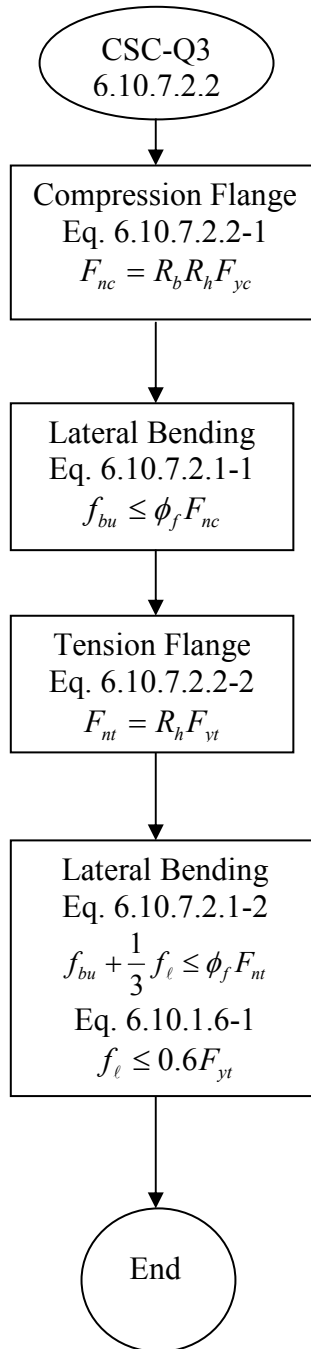

Composite Steel and Concrete Section (CSC)  
LRFD  
CSC Negative Flexure

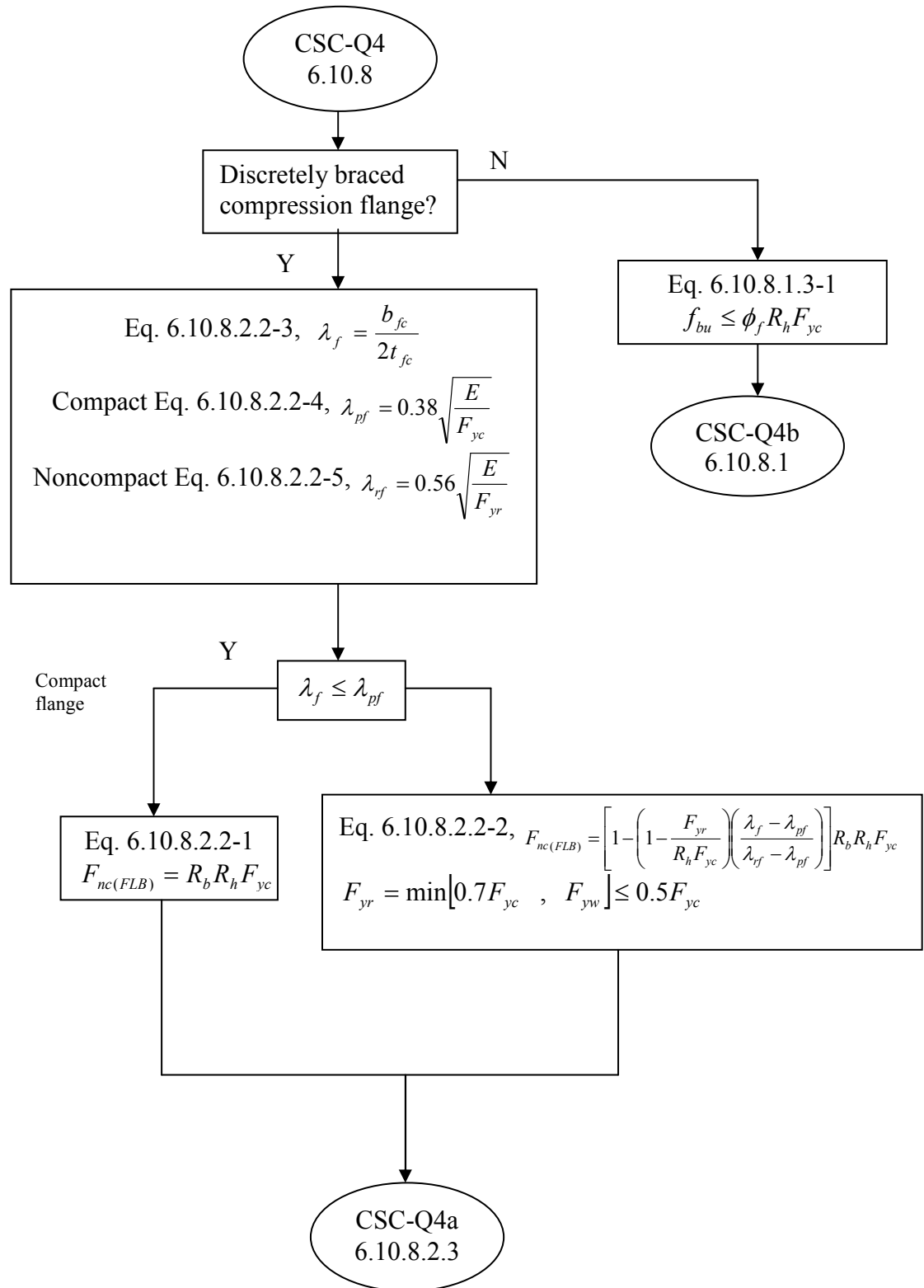



Composite Steel and Concrete Section (CSC)  
LRFD  
CSC Negative Flexure cont.

CSC-Q4a  
6.10.8.2.3

Eq. 6.10.8.2.3.9,  

$$r_t = \frac{b_{fc}}{\sqrt{12 \left( 1 + \frac{1}{3} \frac{D_c t_w}{b_{fc} t_{fc}} \right)}}$$
 Eq. 6.10.8.2.3-4,  $L_p = 1.0 r_t \sqrt{\frac{E}{F_{yc}}}$

Y N

$L_b \leq L_p$

Eq. 6.10.8.2.3-1  
 $F_{nc(LTB)} = R_b R_h F_{yc}$

$F_{yr} = \min[0.7F_{yc}, F_{yw}] \leq 0.5F_{yc}$   
 Eq. 6.10.8.2.3-5,  $L_r = \pi r_t \sqrt{\frac{E}{F_{yr}}}$

Y N  
 $L_p \leq L_b \leq L_r$

Eq. 6.10.8.2.3-2  

$$F_{nc(LTB)} = C_b \left[ 1 - \left( 1 - \frac{F_{yr}}{R_h F_{yc}} \right) \left( \frac{L_b - L_p}{L_r - L_p} \right) \right] R_b R_h F_{yc} \leq R_b R_h F_{yc}$$

Eq. 6.10.8.2.3-8,  $F_{cr} = \frac{C_b \pi^2 E}{\left( L_b / r_t \right)^2}$   
 Eq. 6.10.8.2.3-7  

$$C_b = 1.75 - 1.05 \left( \frac{f_1}{f_2} \right) + 0.3 \left( \frac{f_1}{f_2} \right)^2 \leq 2.3$$

Eq. 6.10.8.2.3-3,  $F_{nc(LTB)} = F_{cr} \leq R_b R_h F_{yc}$

Eq. 6.10.8.2.3  
 $F_{nc} = \min[F_{nc(FLB)}, F_{nc(LTB)}]$

Eq. 6.10.8.1.1-1,  $f_{bu} + \frac{1}{3} f_\ell \leq \phi_f F_{nc}$   
 Eq. 6.10.1.6-1,  $f_\ell \leq 0.6 F_{yt}$

CSC-Q4b  
6.10.8.1

Composite Steel and Concrete Section (CSC)  
LRFD  
CSC Negative Flexure cont.

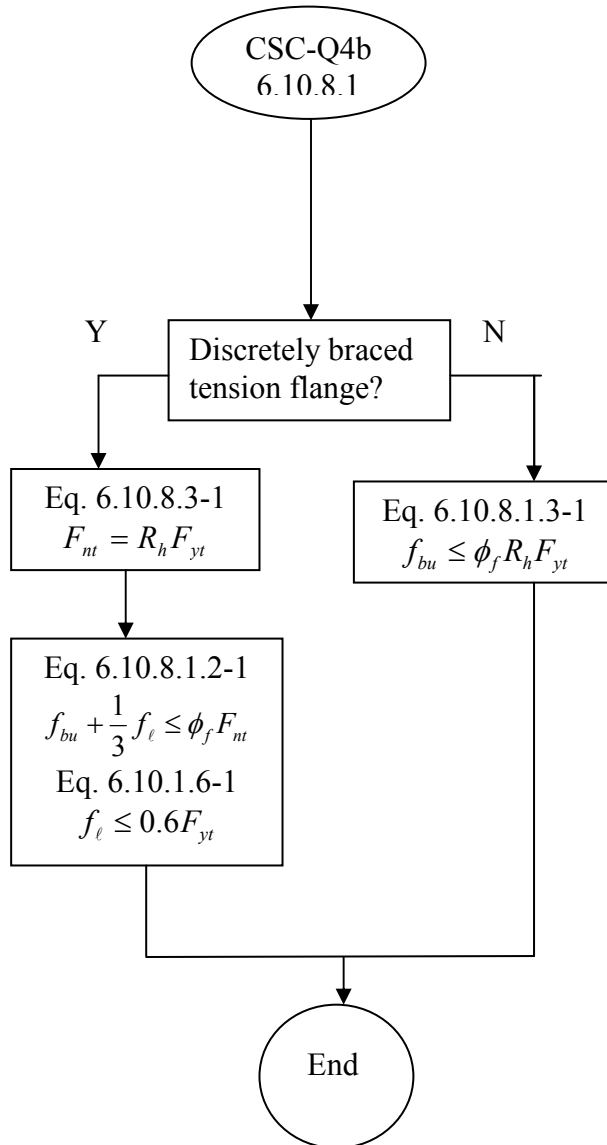

Note: The area of the slab steel is included in the resisting capacity of the steel or composite section when the steel is defined on input (i.e., RT 14), the CP is in the negative moment area (i.e., within 0.3 of the span length either side of the interior supports of continuous members, and then only for positive bending analysis).

**SECTION 1.2.5**

**STRUCTURAL STEEL**

**AND**

**COMPOSITE STEEL AND CONCRETE**

**LOAD RESISTANCE FACTOR DESIGN METHOD**

**SERVICE LIMIT STATE ANALYSIS**

**Structural Steel (SS)/Composite Steel and Concrete (CSC)**  
**LRFD**  
**Service Limit State Analysis Method for SS/CSC Member**

The following are descriptions of the methods for LARS to perform LFD service limit state analysis. The elastic analysis specified in AASHTO LRFD 6.10.4 is used with the Load Combination for Service II in AASHTO LRFD Table 3.4.1-1. The additional requirements for service limit state are shown in SMS-Q1, and the available capacity is calculated by the formula in SMS-M1.

For a SS/CSC member the moment resistance capacity is computed according AASHTO LRFD 6.10.4. In addition, the following requirements must be fulfilled.

SMS-Q1:

Web requirement (6.10.3.2.2): for SS -  $f_{cw} \leq \frac{0.9E\alpha k}{\left(\frac{D}{t_w}\right)^2} \leq F_{yw}$

for CSC -  $f_{cw} \leq \frac{0.9E\alpha k}{\left(\frac{D_c}{t_w}\right)^2} \leq F_{yw}$

Minimum negative slab reinforcement requirement (6.10.3.7):

- a) total cross-sectional area > 1% of total slab cross-section area when:

slab longitudinal tensile stress >  $\phi_r$

or

Load Combination Service II >  $\phi_r$

- b)  $F_y > 60$  ksi

- c) Size > #6 bar

Flange stress (6.10.5.2): for SS -  $f_f \leq 0.95F_{yf}$

for CSC -  $f_f \leq 0.80F_{yf}$

NOTE: If satisfying the qualifications of 6.10.4.4 – moment redistribution may be performed.

SMS-M1:

The value of the available capacity for LL + IMP moment at the section is calculated as follows:

$$CAP_{AVAIL} = [M_r \pm (F_1 \times M_{dl}) \pm (F_2 \times M_{sdl})]$$

where:

	F1	F2	F3
Service State	DL - DC	DL – wearing surface	LL
Service II	1.0	1.0	1.0

**SECTION 1.2.6**

**STRUCTURAL STEEL**

**AND**

**COMPOSITE STEEL AND CONCRETE**

**LOAD RESISTANCE FACTOR DESIGN METHOD**

**FATIGUE LIMIT STATE ANALYSIS**

**Structural Steel (SS)/Composite Steel and Concrete (CSC)**  
**LRFD**  
**Fatigue Limit State Analysis Method for SS/CSC Member**

The following are descriptions of the methods for LARS to perform LFD service limit state analysis. The elastic analysis specified in AASHTO LRFD 6.10.4 is used with the Load Combination for Fatigue in AASHTO LRFD Table 3.4.1-1. The additional requirements for service limit state are shown in FM-Q1, and the available capacity is calculated by the formula in FM-M1. The live load vehicles used for fatigue analysis are either HS20 with the rear axle fully stretched to 30 feet or the tandem vehicle.

For a SS/CSC member the moment resistance capacity is computed according AASHTO LRFD 6.10.4. In addition, the following requirements must be fulfilled.

FM-Q1:

Web requirement (6.10.6.3):

$$\text{If } \frac{D}{t_w} \leq 0.95 \sqrt{\frac{kE}{F_{yw}}}, \text{ then } f_{cf} \leq F_{yw}$$

$$\text{otherwise } f_{cf} \leq 0.9kE \left( \frac{t_w}{D} \right)^2$$

where:

$$D_c \text{ is derived from 6.10.3.1.4a - } D_c = \left[ \frac{|f_c|}{|f_c| + f_t} \right] d - t_f$$

$$\text{with longitudinal stiffeners - } k = 9.0 \left( \frac{D}{D_c} \right)^2 \geq 7.2$$

without longitudinal stiffeners –

$$\text{if } \frac{d_s}{D_c} \geq 0.4, \text{ then}$$

Minimum negative slab reinforcement requirement (6.10.3.7):

- d) total cross-sectional area > 1% of total slab cross-section area  
when:

slab longitudinal tensile stress >

or

Load Combination Service II >  $\phi f_r$

- e)  $F_y < 60$  ksi

- f) Size > #6 bar

Flange stress (6.10.5.2): for SS -  $f_f \leq 0.95F_{yf}$   
for CSC -  $f_f \leq 0.80F_{yf}$



NOTE: If satisfying the qualifications of 6.10.4.4 – moment redistribution may be performed.

SMS-M1:

The value of the available capacity for LL + IMP moment at the section is calculated as follows:

$$CAP_{AVAIL} = [M_r \pm (F_1 \times M_{dl}) \pm (F_2 \times M_{sdl})]$$

where:

	F1	F2	F3
Service State	DL - DC	DL – wearing surface	LL
Fatigue	0.0	0.0	0.75

**SECTION 1.2.3**

**STRUCTURAL STEEL**

**AND**

**COMPOSITE STEEL AND CONCRETE**

**LOAD RESISTANCE FACTOR DESIGN METHOD**

**MOMENT ANALYSIS**

**FOR:**

- **HYBRID GIRDERS**

**Structural Steel (SS)/Composite Steel and Concrete (CSC)**  
**LRFD**  
**Hybrid Girders**

Specification	Reduction Factor	Page
6.10.1.10.1	Reduction Factor	6-80

**Composite Steel and Concrete (CSC) Positive Flexure  
LRFD  
Moment Analysis Method for SS/CSC Hybrid Member**

The following are descriptions of the methods used by LARS to perform LRFD member moment analysis when the structural steel/composite steel and concrete member section is of a hybrid nature (i.e., the strength in the web is higher or lower than one or both of the flanges). The hybrid factor is calculated in MH-1a.

MH-1a:

$$R_h = \frac{12 + \beta(3\rho - \rho^3)}{12 + 2\beta}$$

$R_h = 1.0$  for hybrid section with a higher strength in the web than both flanges

Where:

$$\beta = \frac{2D_n t_w}{A_{fn}}$$

$$\rho = \text{smaller of } \frac{F_{yw}}{f_n} \text{ and } 1.0$$

$A_{fn}$  = area of flange and coverplates on  $D_n$  (SS)  
Including area of longitudinal slab reinforcement (CSC)

$D_n$  = larger of the distance from elastic neutral axis to inside face of flange (SS)  
Distance from the neutral axis to the short-term composite section to inside face of bottom flange (CSC)

$f_n$  = when yields occurs first in the flange or coverplate or longitudinal reinforcement on the side of the neutral axis corresponding to  $D_n$ , largest of yield strength of each component included in  $A_{fn}$ .

**SECTION 1.2.4**

**STRUCTURAL STEEL**

**AND**

**COMPOSITE STEEL AND CONCRETE**

**LOAD RESISTANCE FACTOR DESIGN METHOD**

**Load Shedding Factor**

**Structural Steel (SS)/Composite Steel and Concrete (CSC)**  
**LRFD**  
**Hybrid Girders**

Specification	Reduction Factor	Page
6.10.1.10.2	Reduction Factor	6-81

Structural Steel (SS)/Composite Steel and Concrete (CSC)  
LRFD  
Load Shedding Factor -  $R_b$

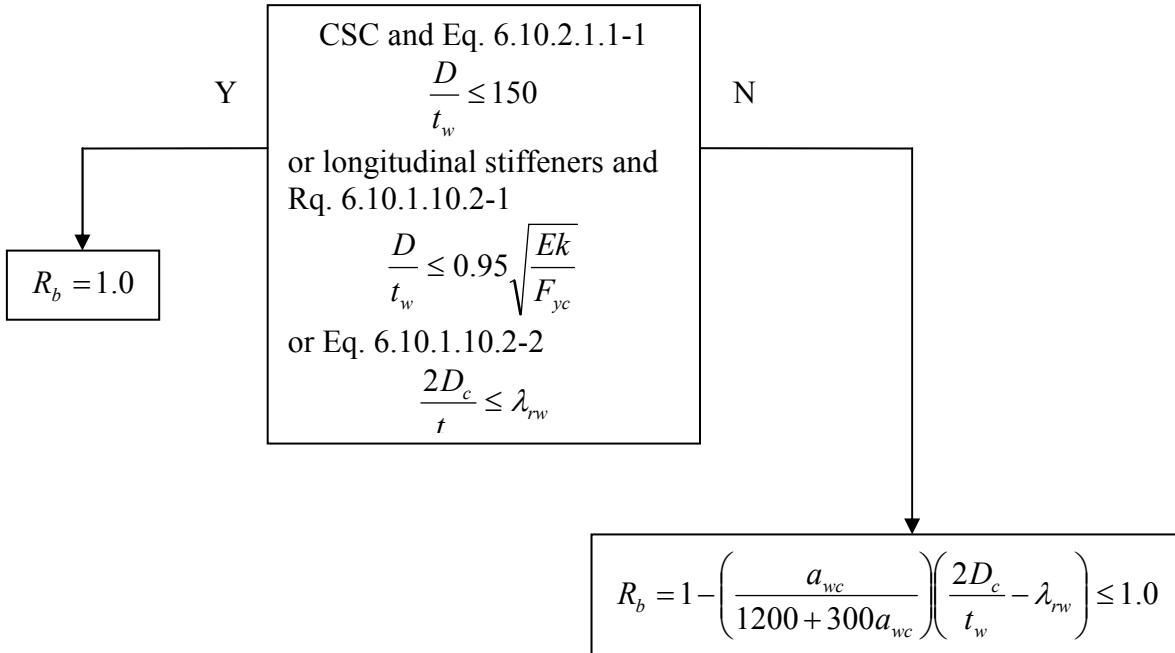

**Structural Steel (SS)/Composite Steel and Concrete (CSC)  
LRFD  
Load Shedding Factor -  $R_b$**

Load shedding factor  $R_b$

ML-2a:

When stiffeners are present or the following equation is satisfied:

If CSC and  $\frac{D}{t_w} \leq 150$

or stiffeners are present and  $\frac{D}{t_w} \leq 0.95 \sqrt{\frac{Ek}{F_{yc}}}$

or webs satisfy  $\frac{2D_c}{t_w} \leq \lambda_{rw}$

Then

$$R_b = 1.0$$

Else

$$R_b = 1 - \left( \frac{a_{wc}}{1200 + 300a_{wc}} \right) \left( \frac{2D_c}{t_w} - \lambda_{rw} \right) \leq 1.0$$

Where:

$$\lambda_{rw} = 5.7 \sqrt{\frac{E}{F_{yc}}}$$

$$a_{wc} = \frac{2D_c t_w}{b_{fc} t_{fc}} \text{ for all sections except below}$$

$$a_{wc} = \frac{2D_c t_w}{b_{fc} t_{fc} + b_s t_s \left(1 - \frac{f_{DC1}}{F_{yc}}\right) / 3n} \text{ for CSC longitudinally stiffened,}$$

positive flexure



**SECTION 1.2.7**

**STRUCTURAL STEEL**

**AND**

**COMPOSITE STEEL AND CONCRETE**

**LOAD RESISTANCE FACTOR DESIGN METHOD**

**FOR**

**SERVICE LIMIT STATE ANALYSIS**

**Structural Steel (SS)/Composite Steel and Concrete (CSC)**  
**LRFD**  
**Service Limit State Analysis**

Specification	Member	Page
6.10.4.2.2*	Non-Composite Structural Steel (SS)	6-93
6.10.4.2.2*	Composite Steel and Concrete (CSC)	6-93

\* Also see LRFR Manual for Condition Evaluation of Bridges,

**Non-Composite Structural Steel (SS)**  
**LRFD**  
**Service Limit State Analysis Method for Structural Steel Members**

The following are descriptions of the methods used by LARS to perform LRFD member Service limit II state analysis when the structural steel member section is of **non-composite construction**. The service capacity is calculated by the formula in SMS-1a, and the available capacity is calculated by the formula in SMS-1b.

SMS-1a:

For a structural steel member of non-composite construction, the maximum service strength at the section  $SM_{CAP}$  is calculated as follows, in accordance with Bridge Specification 6.10.4.2.2:

$$f_f + \frac{f_\ell}{2} \leq 0.80R_h F_{sf}$$

$$SERV \ CAP = \left( f_f + \frac{f_\ell}{2} \right) (S_x)$$

Where:

$f_f$  and  $f_\ell$  are computed from strength limit state  
 $f_\ell \leq 0.6F_{yf}$  from 6.10.1.6

SMS-1b:

The value of the available service capacity for LL + IMP movement at the section is calculated as follows:

$$CAP_{AVAIL} = [M_r \pm (F_1 \times M_{dl}) \pm (F_2 \times M_{sdl})]$$

where:

	F1	F2	F3
Service State	DL - DC	DL – wearing surface	LL
Service I	1.0	1.0	1.0

**Composite Structural Steel and Concrete (CSC)  
LRFD  
Service Limit State Analysis Method for Composite Structural Steel Member**

The following are descriptions of the methods used by LARS to perform LRFD member Service II limit state analysis when the structural steel member section is of **composite construction**. The service capacity is calculated by the formula in SMC-1a, and the available capacity is calculated by the formula in SMC-1b.

SMC-1a:

For a structural steel member of non-composite construction, the maximum service strength at the section  $SM_{CAP}$  is calculated as follows, in accordance with Bridge Specification 6.10.4.2.2-1:

For flanges:

$$f_f \leq 0.95R_h F_{sf}$$

For bottom steel flange:

$$f_f + \frac{f_\ell}{2} \leq 0.95R_h F_{sf}$$

For concrete – except composite sections in positive flexure where the

web satisfies 6.10.2.1.1 ( $\frac{D}{t_w} \leq 150$ )

$$f_c \leq F_{crw}$$

$$SERV \ CAP = \left( f_f , f_f + \frac{f_\ell}{2} \right) (S_x)$$

Where:

$f_f$  and  $f_\ell$  are computed from strength limit state

$$F_{crw} = \frac{0.9Ek}{\left(\frac{D}{t_w}\right)^2} , \quad k = \frac{9}{\left(\frac{D_c}{D}\right)^2} \quad \text{from 6.10.1.9}$$

$$f_\ell \leq 0.6F_{yf} \quad \text{from 6.10.1.6}$$

SMC-1b:

The value of the available service capacity for LL + IMP movement at the section is calculated as follows:

$$CAP_{AVAIL} = [M_r \pm (F_1 \times M_{dl}) \pm (F_2 \times M_{sdl})]$$

where:

	F1	F2	F3
Service State	DL - DC	DL – wearing surface	LL
Service I	1.0	1.0	1.0

**SECTION 1.2.4**

**STRUCTURAL STEEL**

**AND**

**COMPOSITE STEEL AND CONCRETE**

**LOAD FACTOR DESIGN METHOD**

**SHEAR ANALYSIS**

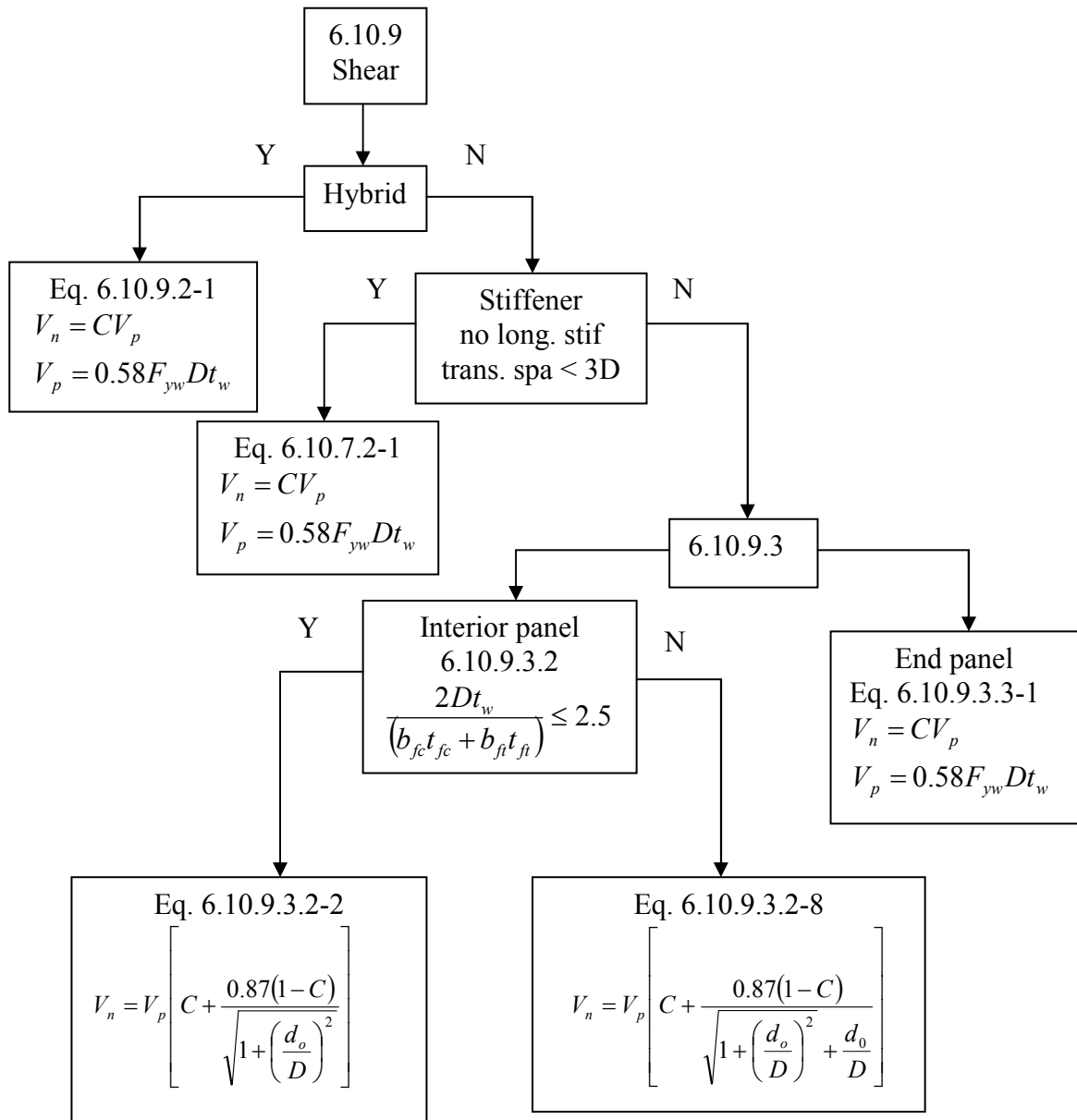

Structural Steel (SS)/Composite Steel and Concrete (CSC)  
LRFD

Specification	Value of c
6.10.9.3	If $\frac{D}{t_w} < 1.12 \sqrt{\frac{Ek}{F_{yw}}}$ , $C = 1.0$ $k = 5 + \frac{5}{\left(\frac{d_o}{D}\right)^2}$
	If $1.12 \sqrt{\frac{Ek}{F_{yw}}} \leq \frac{D}{t_w} \leq 1.40 \sqrt{\frac{Ek}{F_{yw}}}$ , $C = \frac{1.12}{\left(\frac{D}{t_w}\right)} \sqrt{\frac{Ek}{F_{yw}}}$
	If $\frac{D}{t_w} > 1.40 \sqrt{\frac{Ek}{F_{yw}}}$ , $C = \frac{1.57}{\left(\frac{D}{t_w}\right)^2} \left(\frac{Ek}{F_{yw}}\right)$

End panels – 6.10.9.3.3

$$d_0 < 1.5D$$

$$V_p = 0.58F_{yw}Dt_w$$

$$V_n = CV_p$$

Spacing requirements of 6.10.9.3.3

$$V_n = CV_p$$



**Structural Steel (SS)/Composite Steel and Concrete (CSC)**  
**LRFD**  
**Shear Analysis Method for SS/CSC Member**

The following are descriptions of the methods for LARS to perform LFD shear analysis when the member web is **unstiffened** for hybrid and homogeneous members. The shear capacity is calculated by the formula in VS-1a, and the available capacity is calculated by the formula in VS-1b.

For a SS/CSC member with web stiffened, the maximum shear strength at the section  $V_n$  calculated as follows, in accordance with Bridge Specification 6.10.9.2:

VS-Q1:

$$V_n = CV_p$$

where

$$V_p = 0.58F_{yw}Dt_w$$

VS-1a:

For a composite, unbraced, noncompact section, the maximum positive moment strength at the section  $V_r$  is calculated as follows:

$$V_r = \phi_v V_n$$

VS-1b:

The value of the available capacity for LL + IMP moment at the section is calculated as follows:

$$CAP_{AVAIL} = [V_r \pm (F_1 \times V_{dl}) \pm (F_2 \times V_{sdl})]$$

where:

	F1	F2	F3
Service State	DL - DC	DL – wearing surface	LL
Strength I	$\gamma_p$	$\gamma_p$	1.75
Strength II	$\gamma_p$	$\gamma_p$	1.35
Service I	1.0	1.0	1.0

NOTE:  $\gamma_p = 1.25-0.9$  for DC  
 $\gamma_p = 1.50-0.65$  for w.s.

**Structural Steel (SS)/Composite Steel and Concrete (CSC)**  
**LRFD**  
**Shear Analysis Method for SS/CSC Member**

The following are descriptions of the methods for LARS to perform LRFD shear analysis. The shear capacity is calculated by the formula in VS-2a, and the available capacity is calculated by the formula in VS-2b.

Note: Check  $do > 3D$ . If true, issue a warning message.

For a SS/CSC member with unstiffened web, the maximum shear strength at the section  $V_n$  is calculated as follows, in accordance with Bridge Specification 6.10.9.3.3:

VS-Q2a:

$$\text{If } \frac{2Dt_w}{(b_{fc}t_{fc} + b_{ft}t_{ft})} \leq 2.5$$

$$\text{Then } V_n = V_p \left[ C + \frac{0.87(1-C)}{\sqrt{1 + \left(\frac{do}{D}\right)^2}} \right], \text{ for value of C, see page 1-51.}$$

VS-Q2b:

$$\text{If } \frac{2Dt_w}{(b_{fc}t_{fc} + b_{ft}t_{ft})} > 2.5$$

$$\text{Then } V_n = V_p \left[ C + \frac{0.87(1-C)}{\sqrt{1 + \left(\frac{d_o}{D}\right)^2 + \frac{d_o}{D}}} \right], \text{ for value of C, see page 1-51.}$$

Where:

$$V_p = 0.58F_{yw}Dt_w$$

VS-1b:

For a composite, compact section, the maximum shear strength at the section  $V_r$  is calculated as follows:

$$V_r = \phi_v V_n$$

VS-2b:

The value of the available capacity for LL + IMP moment at the section is calculated as follows:

$$CAP_{AVAIL} = [V_r \pm (F_1 \times V_{dl}) \pm (F_2 \times V_{sdl})]$$

	F1	F2	F3	where:
Service State	DL - DC	DL – wearing surface	LL	
Strength I	$\gamma_p$	$\gamma_p$	1.75	
Strength II	$\gamma_p$	$\gamma_p$	1.35	
Service I	1.0	1.0	1.0	

NOTE:  $\gamma_p = 1.25-0.9$  for DC  
 $\gamma_p = 1.50-0.65$  for w.s.

**SECTION 2**

**REINFORCED CONCRETE**

### Reinforced Concrete (RC)<sup>2</sup>

$a$	=	Depth of equivalent rectangular stress block (Article 8.16.2.7).
$A_s$	=	Area of tension reinforcement, sq.in.
$A'_s$	=	Area of compression reinforcement, sq.in.
$A_{sf}$	=	Area of reinforcement to develop compressive strength of overhanging flanges of I- and T-sections (Article 8.16.3.3.2).
$A_v$	=	Area of shear reinforcement within a distance $s$ .
$b$	=	Width of compression face of member.
$b'$	=	$b_w$
$b_w$	=	Web width, or diameter of circular section (Article 8.15.5.1.1).
$CAP_{AVAIL}$	=	Available capacity in moment for Live Load + Impact.
$d$	=	Distance from extreme compression fiber to centroid of tension reinforcement.
$d'$	=	Distance from extreme compression fiber to centroid of compression reinforcement, in.
$f'_c$	=	Specified compression strength of concrete, psi.
$f_s$	=	Tensile stress in reinforcement at service loads, psi (Article 8.15.2.2).
$f_y$	=	Specified yield strength of reinforcement, psi.
$F$	=	Factor of rating type (inventory, operating, posting, etc.)
$h_f$	=	Compression flange thickness of I- and T-sections.
$j$	=	Section value in a reinforced concrete section with ASD related to equivalent moment arm ( $jd$ ).
$k$	=	Section value in a reinforced concrete section with ASD related to equivalent compressive depth ( $kd$ ).

---

<sup>2</sup> Selected symbols and references are based on AASHTO Standard Specifications for Highway Bridges, Sixteenth Edition, while other symbols and references are unique to LARS.

---

$M$	=	Computed moment capacity (Article 8.24.2.3).
$M_{CAP}^*$	=	Moment capacity.
$M_{dl}^*$	=	Dead load moment at the section.
$M_n$	=	Nominal moment strength of a section.
$M_{sdl}^*$	=	Superimposed dead load moment at the section.
$M_u$	=	Factored moment at section.
$n$	=	Modular ratio of elasticity = $E_s/E_c$ (Article 8.15.3.4).
$s$	=	Spacing of shear reinforcement in the direction parallel to the longitudinal reinforcement.
$v_c$	=	Allowable shear stress of concrete.
$v_s$	=	Allowable shear stress of shear reinforcement.
$V$	=	Total shear force at section.
$V_c$	=	Nominal shear strength provided by concrete (Article 8.16.6.1).
$V_s$	=	Nominal shear strength provided by shear reinforcement (Article 8.16.6.1).
$V_u$	=	Factored shear force at section (Article 8.16.6.1).
$V_{AVAIL}^*$	=	Available capacity in shear for Live Load + Impact.
$V_{DL}^*$	=	Dead load shear.
$V_{SDL}^*$	=	Superimposed dead load shear.
$\alpha$	=	Angle between inclined shear reinforcement and longitudinal axis of member.
$\phi$	=	Strength reduction factor (Article 8.16.1.2).
$\rho$	=	Tension reinforcement ratio = $A_s/b_wd$ , $A_s/bd$ .

## Reinforced Concrete (RC)

The various criteria logic that is used to determine the calculation methods for the various analysis conditions are referenced below by number. The calculation methods and formulae are referenced by number.

### ASD

ASD analysis will be performed for every flexural member that has data sufficient for this analysis, regardless of whether an LFD analysis is requested.

Non-Composite:

- All reinforced concrete members will be analyzed as non-composite since composite reinforced concrete member analysis is not included in LARS Release 1.7 or 2.0.
- The values for available capacity for LL + IMP and moment capacity for all non-composite members are calculated by the formulae.

### LFD

Non-Composite:

- All reinforced concrete members will be analyzed as non-composite since composite reinforced concrete member analysis is not included in LARS Release 1.7 or 2.0.
- The values for available capacity for LL + IMP and moment capacity for all non-composite members are calculated by the formulae.

**SECTION 2.1**

**REINFORCED CONCRETE**

**ALLOWABLE STRESS DESIGN METHOD**



**SECTION 2.1.1**

**REINFORCED CONCRETE**

**ALLOWABLE STRESS DESIGN METHOD**

**MOMENT ANALYSIS**

**Reinforced Concrete (RC)**  
**ASD**  
**Moment Analysis Method for Reinforced Concrete Member**

The following are descriptions of the methods used by LARS to perform ASD member moment analysis of a reinforced concrete member. The moment capacity is calculated by the formula in RC-M1a, and the available capacity is calculated by the formula in RC-M1b.

RC-M1a:

For a reinforced concrete member, the moment strength at the section is calculated as follows, in accordance with Bridge Specification 8.15.3:

- a.1 Bending Positive Bottom or Bending Negative Top - Reinforced Steel Capacity

$$M_{CAP} = f_s A_s j d$$

- a.2 Bending Positive Top or Bending Negative Bottom - Concrete Capacity

$$M_{CAP} = n \left( \frac{1-k}{k} \right) (f_c') (A_s j d)$$

RC-M1b:

The value of available capacity for LL + IMP moment at the section is calculated as follows:

$$CAP_{AVAIL} = [M_{cap}] [F] \pm M_{dl} \pm M_{sdl}$$

where for inventory:  $F = 0.55$ , and

for operating and posting:  $F = 0.75$

**SECTION 2.1.2**

**REINFORCED CONCRETE**

**ALLOWABLE STRESS DESIGN METHOD**

**SHEAR ANALYSIS**

**Reinforced Concrete (RC)**

**ASD**

Specification	Shear Reinforcement	Page
8.15.5.2.1 8.15.5.3.2	Vertical Stirrup - Shear Reinforcement Perpendicular to Axis of Member	88
8.15.5.2.1 8.15.5.3.3	Inclined Stirrup - Shear Reinforcement at Angle, Alpha, to Axis of Member	89
8.15.5.2.1 8.15.5.3.4	Single or Single Group of Parallel Bars All Bent Up at Same Distance from Support	90

**Reinforced Concrete (RC)**  
**ASD**  
**Shear Analysis Method for RC Member**

The following are descriptions of the methods for LARS to perform ASD shear analysis when the shear reinforcement is of **vertical stirrups** (i.e., shear reinforcement is perpendicular to the axis of the member). The shear capacity is calculated by the formula in VR-1a, and the available capacity is calculated by the formula in VR-1b.

VR-1a:

For a reinforced concrete member with vertical stirrups, the maximum shear strength at the section  $V_{CAP}$  is calculated as follows, in accordance with Bridge Specifications 8.15.5.2.1 and 8.15.5.3.2:

$$v_c = 0.9\sqrt{f'_c} + 1100\rho_m \left( \frac{V(d)}{M} \right) \leq 1.6\sqrt{f'_c}$$

$$v_s = \frac{A_v f_s}{b_w s}, \text{ and}$$

$$V_{CAP} = (v_c + v_s)b_w d$$

VR-1b:

The value of the available capacity for LL + IMP shear at the section is calculated as follows:

$$V_{AVAIL} = [V_{CAP}] [F] \pm V_{DL} \pm V_{SDL}$$

where for inventory:  $F = 0.55$ , and

for operating and posting:  $F = 0.75$

**Reinforced Concrete (RC)**  
**ASD**  
**Shear Analysis Method for RC Member**

The following are descriptions of the methods for LARS to perform ASD shear analysis when the shear reinforcement is of **inclined stirrups** (i.e., shear reinforcement is at an angle, alpha, with the axis of member). The shear capacity is calculated by the formula in VR-2a, and the available capacity is calculated by the formula in VR-2b.

VR-2a:

For a reinforced concrete member with inclined stirrups, the maximum shear strength at the section  $V_{CAP}$  is calculated as follows, in accordance with Bridge Specifications 8.15.5.2.1 and 8.15.5.3.3:

$$v_c = 0.9\sqrt{f'_c} + 1100\rho_m\left(\frac{V(d)}{M}\right) \leq 1.6\sqrt{f'_c}$$

$$v_s = \frac{A_v f_s (\sin\alpha + \cos\alpha)}{b_w s}, \text{ and}$$

$$V_{CAP} = (v_c + v_s)b_w d$$

VR-2b:

The value of the available capacity for LL + IMP shear at the section is calculated as follows:

$$V_{AVAIL} = [V_{CAP}] [F] \pm V_{DL} \pm V_{SDL}$$

where for inventory:  $F = 0.55$ , and

for operating and posting:  $F = 0.75$

**Reinforced Concrete (RC)  
ASD  
Shear Analysis Method for RC Member**

The following are descriptions of the methods for LARS to perform ASD shear analysis when the shear reinforcement is of a **single bar or a single group of parallel bars all bent up at the same distance from the support**. The shear capacity is calculated by the formula in VR-3a, and the available capacity is calculated by the formula in VR-3b.

VR-3a:

For a reinforced concrete member with shear reinforcement consisting of a single bar or a single group of parallel bars, all bent up at one location, the maximum shear strength at the section  $V_{CAP}$  is calculated as follows, in accordance with Bridge Specifications 8.15.5.2.1 and 8.15.5.3.4:

$$v_c = 0.9\sqrt{f'_c} + 1100\rho_m \left( \frac{V(d)}{M} \right) \leq 1.6\sqrt{f'_c}$$

$$v_s = \frac{A_v f_s \sin \alpha}{b_w d}$$

when  $V_s > 1.5\sqrt{f'_c}(b_w)(d)$  , issue a warning message

$$V_{CAP} = (v_c + v_s)b_w d$$

VR-3b:

The value of the available capacity for LL + IMP shear at the section is calculated as follows:

$$V_{AVAIL} = [V_{CAP}] [F] \pm V_{DL} \pm V_{SDL}$$

where for inventory:  $F = 0.55$ , and

for operating and posting:  $F = 0.75$

**SECTION 2.2**

**REINFORCED CONCRETE**

**LOAD FACTOR DESIGN METHOD**



**SECTION 2.2.1**

**REINFORCED CONCRETE**

**LOAD FACTOR DESIGN METHOD**

**MOMENT ANALYSIS**

**Reinforced Concrete (RC)**

**Member Moment Analysis using LFD**

Specification	Section	Description	Page
8.16.3.2	Rectangular	Tension Reinforcement Only	94
8.16.3.3	Flanged	Tension Reinforcement Only	96
8.16.3.4	Rectangular	Tension and Compression Reinforcement	98
8.16.3.3 and 8.16.3.4	Flanged	Tension and Compression Reinforcement	99

Note: For RC member, tension reinforcement must always be present.

**Reinforced Concrete (RC)  
Load Factor  
Ultimate Moment Capacity**

Rectangular section having tensile reinforcement only:

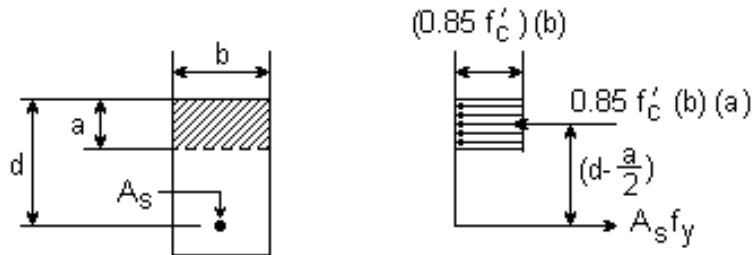

Rectangular  
Section

Flanged section with neutral axis located in the flange and having tensile reinforcement only:

then

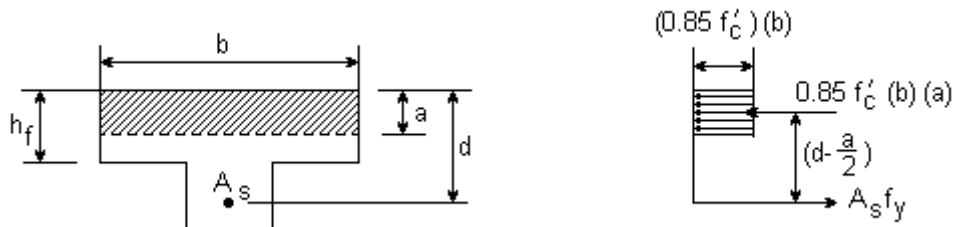

Flanged Section  $a < h_f$

Flanged section with neutral axis located in the stem, and having tensile reinforcement only.

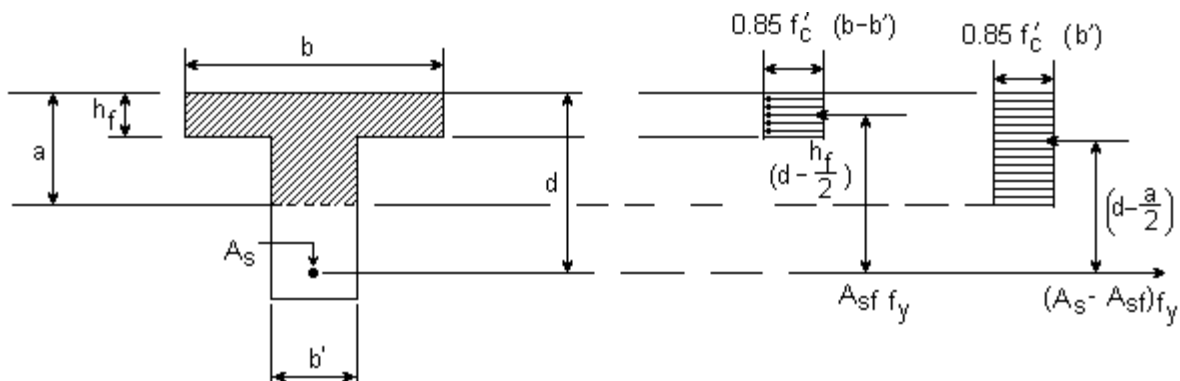

Flanged Section  $a > h_f$

**Reinforced Concrete (RC)  
LFD  
Moment Analysis Method for Reinforced Concrete Member**

The following are descriptions of the methods used by LARS to perform LFD member moment analysis when the member station is a **rectangular section or flanged section with equivalent stress block located in the flange tension reinforcement  $A_s$  only**. The moment capacity is calculated by the formula in RC-M2a, and the available capacity is calculated by the formula in RC-M2b.

RC-M2a:

For a rectangular section or flanged section with an equivalent stress block located in the flange with tension reinforcement only, the maximum moment strength at the section  $M_u$  is calculated as follows, in accordance with Bridge Specification 8.16.3.2:

$$\phi M_n = \left[ A_s f_y \left( d - \frac{a}{2} \right) \right] \phi$$

$$\text{where } a = \frac{A_s f_y}{0.85 (f'_c (b))}$$

$$M_u = \phi M_n$$

RC-M2b:

The value of the available capacity for LL + IMP moment at the section is calculated as follows:

$$CAP_{AVAIL} = \left[ \frac{M_u}{1.3} \pm M_{dl} \pm M_{sdl} \right] [F]$$

$$\text{where for inventory: } F = \frac{3}{5}, \text{ and}$$

$$\text{for operating and posting: } F = 1.0$$

**Reinforced Concrete (RC)  
LFD  
Moment Analysis Method for Reinforced Concrete Member**

The following are descriptions of the methods used by LARS to perform LFD member moment analysis when the member section is of **flanged section with equivalent stress block located in the stem and with tension reinforcement**. The moment capacity is calculated by the formula in RC-M3a, and the available capacity is calculated by the formula in RC-M3b.

RC-M3a:

For a flanged section with equivalent stress block located in the stem and with tension reinforcement only, the maximum moment strength at the section  $M_u$  is calculated as follows, in accordance with Bridge Specification 8.16.3.3:

$$\phi M_n = \left[ (A_s - A_{sf}) f_y \left( d - \frac{a}{2} \right) + A_{sf} f_y (d - 0.5h_f) \right] \phi$$

$$\text{where } A_{sf} = \frac{0.85 f'_c (b - b_w) h_f}{f_y}$$

$$\text{and } a = \frac{(A_s - A_{sf}) f_y}{0.85 (f'_c) (b)}$$

$$M_u = \phi M_n$$

RC-M3b:

The value of available capacity for LL + IMP moment at the section is calculated as follows:

$$CAP_{AVAIL} = \left[ \frac{M_u}{1.3} \pm M_{dl} \pm M_{sdl} \right] [F]$$

$$\text{where for inventory: } F = \frac{3}{5}, \text{ and}$$

$$\text{for operating and posting: } F = 1.0$$

Rectangular section with tensile and compressive reinforcement.

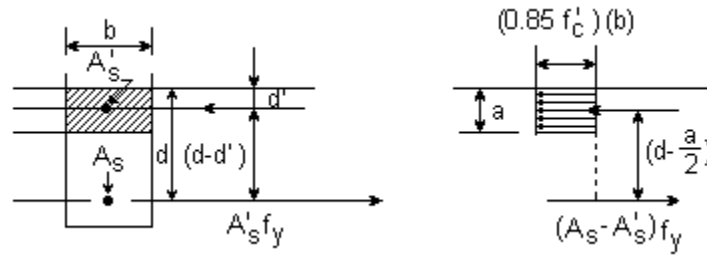

Rectangular Section

Flanged section with neutral axis located in the flange, with tensile and compressive reinforcement.

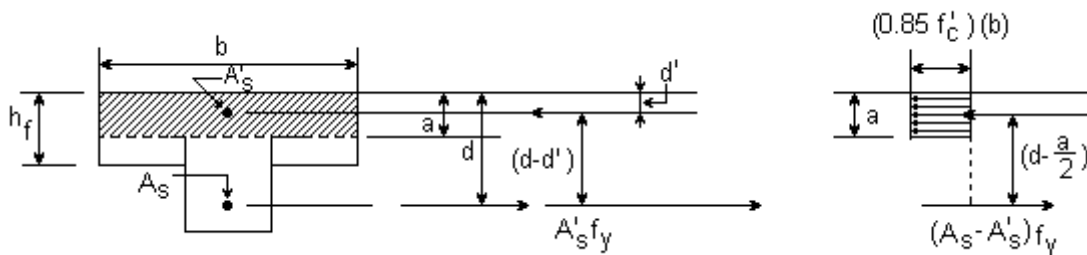

Flanged Section,  $a < h_f$

Flanged section with neutral axis located in the stem, with tensile and compressive reinforcement.

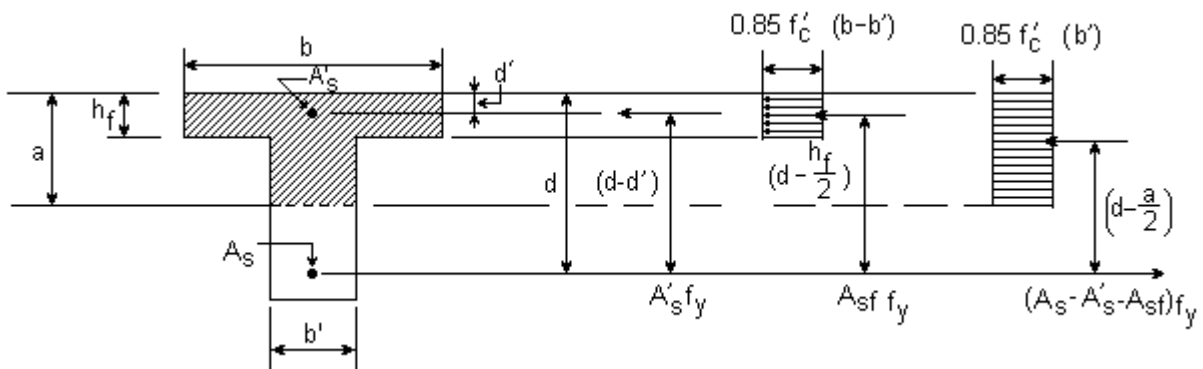

Flanged Section,  $a > h_f$

**Reinforced Concrete (RC)  
LFD  
Moment Analysis Method for Reinforced Concrete Members**

The following are descriptions of the methods for LARS to perform LFD member moment analysis when the member section is **a rectangular section or flanged section with equivalent stress block located in the flange and with tension reinforcement  $A_s$ , and compression reinforcement  $A_s'$** . The moment capacity is calculated by the formula in RC-M4a, and the available capacity is calculated by the formula in RC-M4b.

RC-M4a:

For a rectangular section or flanged section with an equivalent stress block located in the flange and with tension reinforcement and compression reinforcement, the maximum moment strength at the section  $M_u$  is calculated as follows, in accordance with Bridge Specification 8.16.3.4:

$$\phi M_n = \left[ \left( A_s - A_s' \right) f_y \left( d - \frac{a}{2} \right) + A_s' f_y (d - d') \right] \phi$$

$$\text{where } a = \frac{\left( A_s - A_s' \right) f_y}{0.85 \left( f_c' \right) (b)}$$

$$M_u = \phi M_n$$

RC-M4b:

The value of the available capacity for LL + IMP moment at the section is calculated as follows:

$$CAP_{AVAIL} = \left[ \frac{M_u}{1.3} \pm M_{dl} \pm M_{sdl} \right] [F]$$

$$\text{where for inventory: } F = \frac{3}{5}, \text{ and}$$

$$\text{for operating and posting: } F = 1.0$$

**Reinforced Concrete (RC)  
LFD  
Moment Analysis Method for Reinforced Concrete Member**

The following are descriptions of the methods for LARS to perform LFD member moment analysis, when the member section is of a **flanged section with the equivalent stress block located in the stem, with tension reinforcement  $A_s$ , and compression reinforcement  $A_s'$** . The moment capacity is calculated by the formula in RC-M5a, and the available capacity is calculated by the formula in RC-M5b.

RC-M5a:

For a flanged section with an equivalent stress block located in the stem, with tension reinforcement and compression reinforcement, the maximum moment strength at the section  $M_u$  is calculated as follows, in accordance with Bridge Specifications 8.16.3.3 and 8.16.3.4:

$$\phi M_n = \left[ \left( A_s - A_s' - A_{sf} \right) f_y \left( d - \frac{a}{2} \right) + A_s' f_y (d - d') + A_{sf} f_y (d - 0.5h_f) \right] \phi$$

where  $A_{sf} = \frac{0.85 f_c' (b - b') h_f}{f_y}$

and  $a = \frac{\left( A_s - A_s' - A_{sf} \right) f_y}{0.85 (f_c') (b)}$

$$M_u = \phi M_n$$

RC-M5b:

The value of the available capacity for LL + IMP moment at the section is calculated as follows:

$$CAP_{AVAIL} = \left[ \frac{M_u}{1.3} \pm M_{dl} \pm M_{sdl} \right] [F]$$

where for inventory:  $F = \frac{3}{5}$ , and

for operating and posting:  $F = 1.0$



**SECTION 2.2.2**

**REINFORCED CONCRETE**

**LOAD FACTOR DESIGN METHOD**

**SHEAR ANALYSIS**

**Reinforced Concrete (RC)**

**LFD**

Specification	Shear Reinforcement	Page
8.16.6.2.1 8.16.6.3.2	Vertical Stirrup - Shear Reinforcement Perpendicular to the Axis of Member	102
8.16.6.2.1 8.16.6.3.3	Inclined Stirrup - Shear Reinforcement at an Angle, Alpha, to the Axis of Member	103
8.16.6.2.1 8.16.6.3.4	Single Bar or Single Group of Parallel Bars All Bent Up at Same Distance from Support	104

**Reinforced Concrete (RC)**  
**LFD**  
**Shear Analysis Method for RC Member**

The following are descriptions of the methods for LARS to perform LFD shear analysis when the shear reinforcement is of **vertical stirrups** (i.e., shear reinforcement is perpendicular to the axis of the member). The shear capacity is calculated by the formula in VR-1a, and the available capacity is calculated by the formula in VR-1b.

VR-1a:

For a reinforced concrete member with vertical stirrups, the maximum shear strength at the section  $V_u$  is calculated as follows, in accordance with Bridge Specifications 8.16.6.2.1 and 8.16.6.3.2:

$$V_c = \left[ 1.9\sqrt{f'_c} + 2500\rho_m \left( \frac{V(d)}{M} \right) \right] (b_w)(d) \leq 3.5\sqrt{f'_c} (b_w)(d)$$

$$V_s = \frac{A_v f_y d}{s}$$

$$V_u = 0.85[V_c + V_s]$$

VR-1b:

The value of the available capacity for LL + IMP shear at the section is calculated as follows:

$$V_{AVAIL} = \left[ \left( \frac{V_u}{1.3} \right) \pm V_{DL} \pm V_{SDL} \right] [F]$$

where for inventory  $F = \frac{3}{5}$ , and

for operating and posting  $F = 1.0$

**Reinforced Concrete (RC)**  
**LFD**  
**Shear Analysis Method for RC Member**

The following are descriptions of the methods for LARS to perform LFD shear analysis when the shear reinforcement is of **inclined stirrups** (i.e., the shear reinforcement is at an angle, alpha, with the axis of the member). The shear capacity is calculated by the formula in VR-2a, and the available capacity is calculated by the formula in VR-2b.

VR-2a:

For a reinforced concrete member with included stirrups, the maximum shear strength at the section  $V_u$  is calculated as follows, in accordance with Bridge Specifications 8.16.6.2.1 and 8.16.6.3.3:

$$V_c = \left[ 1.9\sqrt{f'_c} + 2500\rho_m \left( \frac{V(d)}{M} \right) \right] (b_w)(d) \leq 3.5\sqrt{f'_c} (b_w)(d)$$

$$V_s = \frac{A_v f_y d}{s} (\sin \alpha + \cos \alpha)$$

$$V_u = 0.85[V_c + V_s]$$

VR-2b:

The value of the available capacity for LL + IMP shear at the section is calculated as follows:

$$V_{AVAIL} = \left[ \left( \frac{V_u}{1.3} \right) \pm V_{DL} \pm V_{SDL} \right] [F]$$

where for inventory  $F = \frac{3}{5}$ , and

for operating and posting  $F = 1.0$

**Reinforced Concrete (RC)  
LFD  
Shear Analysis Method for RC Member**

The following are descriptions of the methods for LARS to perform LFD shear analysis when the shear reinforcement is of a **single bar, or a single group of parallel bars, all bent up at the same distance from the support**. The shear capacity is calculated by the formula in VR-3a, and the available capacity is calculated by the formula in VR-3b.

VR-3a:

For a reinforced concrete member with shear reinforcement consisting of a single bar or a single group of parallel bars all bent up at one location. The maximum shear strength at the section  $V_u$  is calculated as follows, in accordance with Bridge Specifications 8.16.6.2.1 and 8.16.6.3.4:

$$V_c = \left[ 1.9\sqrt{f'_c} + 2500\rho_m \left( \frac{V(d)}{M} \right) \right] (b_w)(d) \leq 3.5\sqrt{f'_c} (b_w)(d)$$

$$V_s = A_v f_y (\sin \alpha) < 3\sqrt{f'_c} (b_w)(d)$$

$$V_u = 0.85[V_c + V_s]$$

VR-3b:

The value of the available capacity for LL + IMP shear at the section is calculated as follows:

$$V_{AVAIL} = \left[ \left( \frac{V_u}{1.3} \right) \pm V_{DL} \pm V_{SDL} \right] [F]$$

where for inventory  $F = \frac{3}{5}$ , and

for operating and posting  $F = 1.0$

**SECTION 2.2.2**

**REINFORCED CONCRETE**

**LOAD RESISTANCE DESIGN METHOD**

**STRENGTH MOMENT ANALYSIS**

LRFD RC

Check Minimum  
Reinforcement  
5.7.3.3.2

Compute “c” – Eq. 5.7.3.1.1-4  
using rectangular formula

$$c = \frac{A_s f_s - A'_s f'_s}{0.85 f'_c \beta_1 b}$$

Y

Check “c” ≤ top flange depth

N

Rectangular behavior

$$c = \frac{A_s f_s - A'_s f'_s}{0.85 f'_c \beta_1 b}$$

T-section behavior

$$c = \frac{A_s f_s - A'_s f'_s + 0.85 f'_c (b - b_w) h_f}{0.85 f'_c \beta_1 b_w}$$

Compute  $\Phi$  – Eq. 5.5.4.2.1-2

$$0.75 \leq \phi = 0.65 + 0.15 \left( \frac{d_t}{c} - 1 \right) \leq 0.9$$

$$a = c \beta_1$$

$$M_n = \left[ A_s f_y \left( d_s - \frac{a}{2} \right) + A'_s f'_y \left( d'_s - \frac{a}{2} \right) + 0.85 f'_c (b - b_w) h_f \left( \frac{a}{2} - \frac{h_f}{2} \right) \right]$$

Check minimum reinforcement - 5.7.3.2.2

$$M_r \geq \min(1.22 * M_{cr}, 1.33M_n)$$

Eq. 5.7.3.3.2-1

$$M_{cr} = S_c (f_r + f_{cpe}) - M_{dnc} \left( \frac{S_c}{S_{nc}} - 1 \right) \geq S_c f_r$$

$$M_n = \gamma_{DC} M_{DL} + \gamma_{DW} M_{SDL} + \gamma_L M_{LL+I}$$



**Reinforced Concrete (RC)  
LRFD  
Strength Moment Analysis Method for Reinforced Concrete Member**

The following are descriptions of the methods for LARS to perform LRFD member strength moment analysis, when the member section is of a **flanged section with the equivalent stress block located in the stem, with tension reinforcement  $A_s$ , and compression reinforcement  $A'_s$** . The moment resistance is calculated by the formula in RC-M1a, and the available resistance is calculated by the formula in RC-M1b.

RC-M1a:

For a flanged section with an equivalent stress block located in the stem, with tension reinforcement and compression reinforcement, the maximum moment strength at the section  $M_u$  is calculated as follows, in accordance with Bridge Specifications 5.7.3.2.2, 5.7.3.3.2:

$$M_n = \left[ A_s f_y \left( d_s - \frac{a}{2} \right) + A'_s f'_y \left( d'_s - \frac{a}{2} \right) + 0.85 f'_c (b - b_w) h_f \left( \frac{a}{2} - \frac{h_f}{2} \right) \right]$$

$$a = c \beta_1$$

where:

$$\text{for flanged sections: } c = \frac{\left[ A_s f_s - A'_s f'_s + 0.85 f'_c (b - b_w) h_f \right]}{0.85 f'_c \beta_1 b_w}$$

$$\text{for rectangular sections: } c = \frac{A_s f_s - A'_s f'_s}{0.85 f'_c \beta_1 b}$$

$$M_r = \phi_f M_n$$

$$\text{where: } 0.75 \leq \phi_f = 0.65 + 0.15 \left( \frac{d_t}{c} - 1 \right) \leq 0.9$$

$$M_r \geq \min(1.22 * M_{cr}, 1.33 M_n)$$

where:

$$M_{cr} = S_c (f_r) \geq S_c f_r$$

$$M_n = \gamma_{DC} M_{DL} + \gamma_{DW} M_{SDL} + \gamma_L M_{LL+I}$$

RC-M1b:

The value of the available resistance for LL + IMP moment at the section is calculated as follows:

$$RES_{AVAIL} = [M_r \pm (F_1 \times M_{dl}) \pm (F_2 \times M_{sdl})]$$

where:

	F1	F2	F3
Limit State	DL - DC	DL – wearing surface	LL
Strength I	$\gamma_p$	$\gamma_p$	1.75
Strength II	$\gamma_p$	$\gamma_p$	1.35
Service I	1.0	1.0	1.0

NOTE:             $\gamma_p = 1.25-0.9$  for DC  
                        $\gamma_p = 1.50-0.65$  for w.s.

**SECTION 2.2.2**

**REINFORCED CONCRETE**

**LOAD RESISTANCE DESIGN METHOD**

**STRENGTH SHEAR ANALYSIS**

**Reinforced Concrete (RC)  
LRFD  
Strength Shear Analysis Method for RC Member**

The following are descriptions of the methods for LARS to perform LRFD shear analysis when the shear reinforcement is of **vertical stirrups** (i.e., shear reinforcement is perpendicular to the axis of the member). The shear resistance is calculated by the formula in VR-1a, and the available resistance is calculated by the formula in VR-1b.

VR-1a:

For a reinforced concrete member with vertical stirrups, the maximum shear strength at the section  $V_n$  is calculated as follows, in accordance with Bridge Specifications 5.8.3.3, and 5.8.2.5 :

Where:

$$A_v \geq 0.0316 \sqrt{f'_c} \frac{b_v s}{f_y} \text{ and } H < 16$$

The simplified procedure described in 5.8.3.4.1 may be used:

$$\beta = 2.0$$

$$\theta = 45^\circ$$

$$V_c = 0.0316 \beta \sqrt{f'_c} (b_v) (d_v)$$

OR the simplified procedure described in 5.3.8.4.3 may be used:

$$V_{ci} = .02 \sqrt{f'_c} b_v d_v + V_d + \frac{V_i M_{cre}}{M_{MAX}} \geq 1.7 \sqrt{f'_c} b_v d_v$$

$$\text{where: } M_{cre} = S_c \left( f_r - \frac{M_{dnc}}{S_{nc}} \right)$$

$$f_r = 0.2 \sqrt{f'_c}$$

$$S_c = S_{nc}$$

$$V_{cw} = \left( 0.06 \sqrt{f'_c} \right) b_v d_v + V_p$$

$$\text{where: } f_{pc} = \frac{M_{dl} \left( \bar{y} - C_b \right)}{I_x}$$

$$\bar{y} = \frac{I_{x(n=n)}}{S_b}$$

$C_b$  is for non-composite section.

$$V_c = \text{MIN}(V_{ci}, V_{cw})$$

When  $V_{ci} < V_{cw}$   $\cot \theta = 1.0$

Or  $V_{ci} \geq V_{cw}$   $\cot \theta = 1.0 + 3 \left( \frac{f_{pc}}{\sqrt{f'_c}} \right)$

For either simplified procedure:

$$V_s = \frac{A_v f_y d_v (\cot \theta + \cot \alpha) \sin \alpha}{s}$$

lesser of:

$$V_n = V_c + V_s + V_p \quad (\text{for 5.8.3.4.3, } V_p = 0)$$

$$V_n = 0.25 f'_c b_v d_v \quad (\text{for 5.8.3.4.3, } V_p = 0)$$

VR-1b:

$$V_r = \phi_v V_n$$

where:  $\phi_v = \phi_f$ , except lightweight concrete where  $\phi_v = 0.70$

VR-1c:

The value of the available resistance for LL + IMP moment at the section is calculated as follows:

$$RES_{AVAIL} = [V_r \pm (F_1 \times V_{dl}) \pm (F_2 \times V_{sdl})]$$

where:

	F1	F2	F3
Limit State	DL - DC	DL – wearing surface	LL
Strength I	$\gamma_p$	$\gamma_p$	1.75
Strength II	$\gamma_p$	$\gamma_p$	1.35
Service I	1.0	1.0	1.0

NOTE:  $\gamma_p = 1.25-0.9$  for DC  
 $\gamma_p = 1.50-0.65$  for w.s.

**SECTION 2.2.3**

**REINFORCED CONCRETE**

**LOAD RESISTANCE DESIGN METHOD**

**SERVICE ANALYSIS**

**Reinforced Concrete (RC)  
LRFD  
Service Analysis Method for RC Member**

The following are descriptions of the methods for LARS to perform LRFD Service I Limit State analysis

**SR-1a:**

For a reinforced concrete members, the service limit stress in the reinforcement is computed using an elastic model of the cracked concrete section with transformed steel.

Compute:  $Stress\ ratio = \frac{f_R}{f_s}$

Where:

$$f_{LL+P} = 2n \times \frac{(M_{LL+IL})_{l2} \times (d_t - \bar{y}_{n=2n})}{I_{n=2n}}$$

Where  $\bar{y}, I_{n=n}, I_{n=2n}$  are computed based on location  $\bar{y}$  in slab,

$$\bar{y}_{n=n} = \frac{b_e \times \bar{y} \left( \frac{\bar{y}}{2} \right) + (n \times A_s d_s)}{(b_e \times \bar{y}) + (n \times A_s)},$$

$$I_{n=n} = \frac{1}{12} b_e \bar{y}^3 + (b_e \bar{y}) \left( \frac{\bar{y}}{2} \right)^2 + (n \times A_s (d_s - \bar{y})^2)$$

$\bar{y}$  in beam,

$$\bar{y}_{n=n} = \frac{(b_e - t_w) \times t_s \left( \frac{t_s}{2} \right) + (t_w \times \bar{y}) \left( \frac{\bar{y}}{2} \right) + (n \times A_s d_s)}{(b_e - t_w) \times t_s + (t_w \times \bar{y}) + (n \times A_s)}$$

$$I_{n=n} = \frac{1}{12} (b_e - t_w) t_s^3 + (b_e - t_w) t_s \left( \bar{y} - \frac{t_s}{2} \right)^2 + \frac{1}{12} t_w \bar{y}^3 + (\bar{y} \times t_w) \left( \frac{\bar{y}}{2} \right)^2 + n \times A_s (d_s - \bar{y})^2$$

$$f_s = f_{LL+I} + f_{DL}$$

$$f_R = 0.9 f_y$$

NOTE: When the stress ratio is less than 1, the rating factor is the value of the stress ratio



**SECTION 3**

**PRESTRESSED CONCRETE**

**AND**

**COMPOSITE PRESTRESSED CONCRETE**

### Prestressed Concrete (PSC)<sup>3</sup>

$a$	=	Depth of compression block.
$a_{low}$	=	Distance from centroid of prestressing steel to lowest strand.
$A$	=	Area of prestressed concrete beam.
$A_s$	=	Area of non-prestressed tension reinforcement (Article 9.19).
$A_{sf}$	=	Steel area required to develop the compressive strength of the overhanging portions of the flange (Article 9.17).
$A_{sr}$	=	Steel area required to develop the compressive strength of the web of a flanged member section (Articles 9.17 - 9.19).
$A'_s$	=	Area of compression reinforcement (Article 9.19).
$A_s^*$	=	Area of prestressing steel (Article 9.17).
$A_{SL}$	=	Area of slab reinforcement.
$A_v$	=	Area of web reinforcement (Article 9.20).
$b$	=	Width of flange of flanged member or width of rectangular member.
$b'$	=	Width of a web of a flanged member.
$b_{SLAB}$	=	Effective width of the slab.
$b_{TOPFLG}$	=	Width of top flange of the concrete section.
$b_{WEB}$	=	$b'$
$c$	=	Distance to the neutral axis from the top of the section.
$C$	=	Total compressive force in the section.
$CAP_{AVAIL}$	=	Available moment capacity of the section.
$C_l$	=	Equivalent compressive force to develop rectangular portion of the section.

---

<sup>3</sup> Selected symbols and references are based on AASHTO Standard Specifications for Highway Bridges, Sixteenth Edition, while other symbols and references are unique to LARS.

---

$C_2$	=	Equivalent compressive force to develop overhung flanges of the section.
$d$	=	Distance from extreme compressive fiber to centroid of the prestressing force.
$d'$	=	Distance of the centroid of slab reinforcement from the top of the section.
$d_t$	=	Distance from the extreme compressive fiber to the centroid of the non-prestressed tension reinforcement (Articles 9.17 - 9.19).
$d_{SL}$	=	Distance from centroid of slab reinforcement to bottom of section.
$e$	=	$e_c$
$e_c$	=	Distance to centroid of PS/C beam from centroid of prestressing force.
$E_c$	=	Strain at extreme compression fiber.
$f'_c$	=	Compressive strength of concrete at 28 days.
$f'_{cSLAB}$	=	$f'_c$ of the slab.
$f_d$	=	Stress due to unfactored dead load, at extreme fiber of section when tensile stress is caused by externally applied loads (Article 9.20).
$f_{pc}$	=	Compressive stress in concrete (after allowance for all prestress losses) at centroid of cross section resisting externally applied loads or at junction of web and flange when the centroid lies within the flange. (In a composite member, $f_{pc}$ is resultant compressive stress at centroid of composite section, or at junction of web and flange when the centroid lies within the flange, due to both prestress and moments resisted by precast member acting alone.) (Article 9.20)
$f_{pe}$	=	Compressive stress in concrete due to effective prestress forces only (after allowance for all prestress losses) at extreme fiber of section where tensile stress is caused by externally applied loads (Article 9.20).
$f'_s$	=	Ultimate stress of prestressing steel (Articles 9.15 and 9.17).
$f_{su}^*$	=	Average stress in prestressing steel at ultimate load.
$f_{sy}$	=	Yield stress of non-prestressed conventional reinforcement in tension (Articles 9.19 and 9.20).
$f'_{sy}$	=	$f'_y$
$f_{sySLAB}$	=	Yield stress of slab reinforcement.

$f'_y$	=	Yield stress of non-prestressed conventional reinforcement (Article 9.19).
$F$	=	Factor of rating type (inventory, operating, posting, etc.)
$F_f$	=	Final prestressing force.
$Min$	=	Minimum
$M_{cr}$	=	Moment causing flexural cracking at section due to externally applied loads (Article 9.20).
$M_{cr}^*$	=	Cracking moment (Article 9.18).
$M_{dl}$	=	Dead load moment at the section.
$M_{sdl}$	=	Superimposed dead load moment at the section.
$M_u$	=	Factored moment at section $\leq \phi M_n$ (Articles 9.17 and 9.18).
$M_{MAX}$	=	Maximum total moment at the section.
$p$	=	$A_s/bd_t$ , ratio of non-prestressed tension reinforcement (Articles 9.17 - 9.19).
$p_{sl}$	=	$A_{sl}/db$ , ratio of slab reinforcement.
$p'$	=	$A'_s/bd$ , ratio of compression reinforcement (Article 9.19).
$p^*$	=	$A_s^*/bd$ , ratio of prestressing steel (Articles 9.17 and 9.19).
$S$	=	Section modulus of the section.
$S_b^+$	=	Section modulus at bottom fiber of the section for positive bending moment.
$S_b^-$	=	Section modulus at bottom fiber of the section for negative bending moment.
$S_t^+$	=	Section modulus at top fiber of the section for positive bending moment.
$S_t^-$	=	Section modulus at top fiber of the section for negative bending moment.
$SM_{CAP}$	=	Serviceability moment capacity.
$t$	=	Average thickness of the flange of a flanged member (Articles 9.17 and 9.18).
$t_{BOTFLG}$	=	Thickness of bottom flange of the concrete section.

---

$T$	=	Total tension force in a section.
$T_1$	=	Equivalent tension force to develop rectangular portion of the section.
$T_2$	=	Equivalent tension force to develop overhung portion of the section.
$V_c$	=	Nominal shear strength provided by concrete (Article 9.20).
$V_{ci}$	=	Nominal shear strength provided by concrete when diagonal cracking results from combined shear and moment (Article 9.20).
$V_{cw}$	=	Nominal shear strength provided by concrete when diagonal cracking results from excessive principal tensile stress in web (Article 9.20).
$V_d$	=	Shear force at section due to unfactored dead load (Article 9.20).
$V_i$	=	Factored shear force at section due to externally applied loads occurring simultaneously with $M_{max}$ (Article 9.20).
$V_p$	=	Vertical component of effective prestress force at section (Article 9.20).
$V_s$	=	Nominal shear strength provided by shear reinforcement (Article 9.20).
$V_u$	=	Factored shear force at section (Article 9.20).
$V_{AVAIL}$	=	Available shear capacity for Live Load + Impact.
$V_{DL}$	=	Dead load shear at the section.
$V_{SDL}$	=	Superimposed dead load shear at the section.
$Y_t$	=	Distance from centroidal axis of gross section, neglecting reinforcement, to extreme fiber in tension (Article 9.20).
$Z$	=	Equivalent section modulus.
$\beta_1$	=	Factor for concrete strength as defined in Article 8.16.2.7 (Articles 9.17 - 9.19). $\beta_1 = 0.85$ for $f'_c \leq 4000ps$ $\beta_1 = 0.85 - (0.05)(f'_c - 4000) / 1000 \geq 0.65$

## Prestressed Concrete (PSC) and Composite Prestressed Concrete (CPS)

The various criteria logic that is used to determine the calculation methods for the above listed conditions are referenced below by number. The calculation methods and formulae are referenced by number.

### ASD

The elastic stresses are checked to satisfy the Allowable Stress Design method.

### LFD

Non-Composite:

A section will be considered as non-composite if the member is designated as PSC, or if the member is designated as CPS, but the section is located in a range designated as non-composite.

1. Rectangular Section Analysis, PSC

The values for non-composite moment capacity and for available capacity for LL + IMP are calculated by the formulae PS-M1a and PS-M1b to PS-M3a and PS-M3b, depending upon whether a section has tension and/or compression non-prestressed reinforcing steel and whether the reinforcing index is  $\leq \beta_1$ .

2. I-Shape Section Analysis, PSC

The values for non-composite moment capacity and for available capacity for LL + IMP are calculated by the formulae PS-M4a and PS-M4b to PS-M9a and PS-M9b, depending upon whether a section has tension and/or compression non-prestressed reinforcing steel, the depth of the compression stress block is greater or less than the I section flange and whether the reinforcing index is  $\leq \beta_1$ .

Composite:

A section will be considered as composite if the member is designated as CPS, and the section is located in a range designated as composite.

1. I-Shape Section Analysis, PSC

The values for non-composite moment capacity and for available capacity for LL + IMP are calculated by the formulae CP-M1a and CP-M1b to CP-M6a and CP-M6b, depending upon whether a section has tension and/or compression non-prestressed reinforcing steel, the depth of the compression stress block is greater or less than the I section flange and whether the reinforcing index is  $\leq \beta_1$ .

Prestressed and Composite Sections

Case I

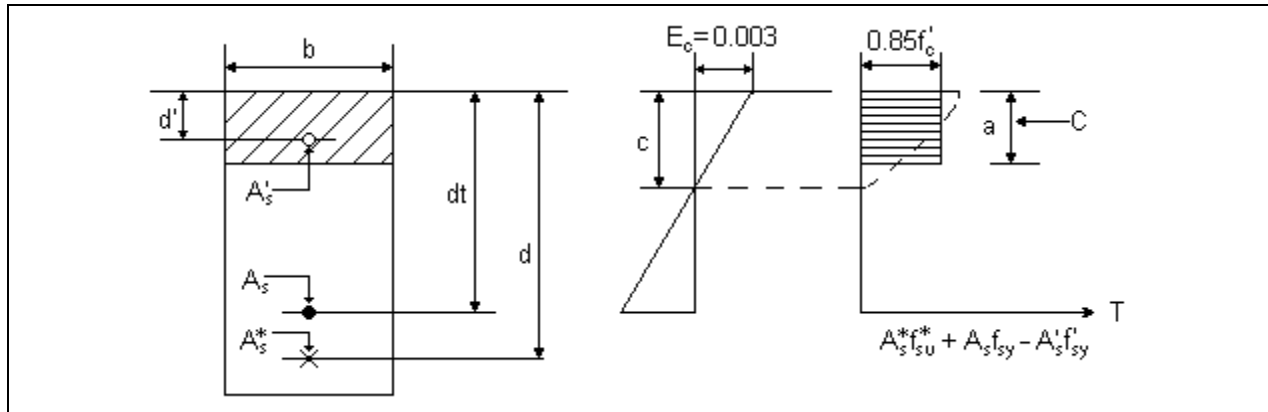

Case II

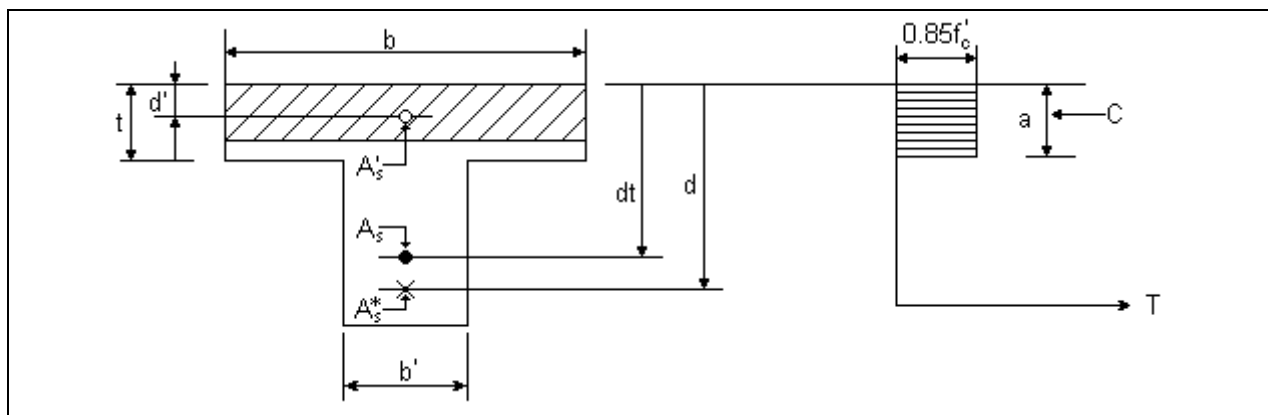

Case III

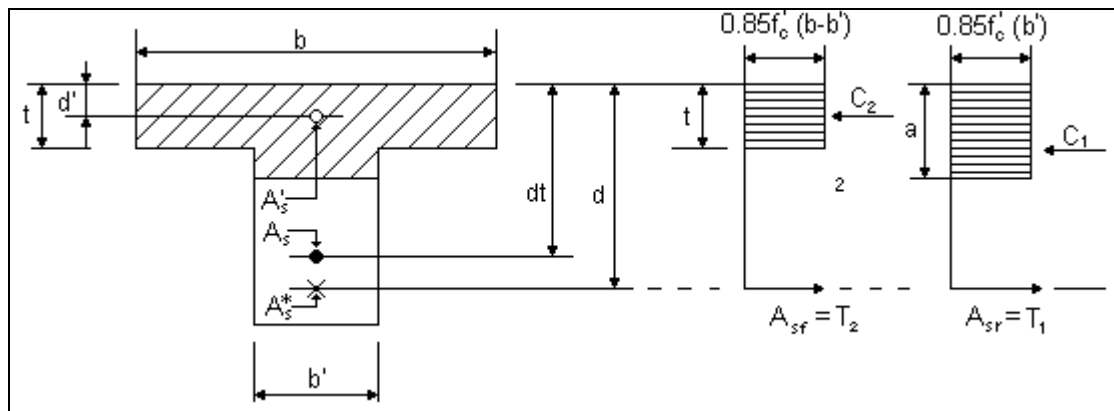

**SECTION 3.1**

**PRESTRESSED CONCRETE**

**AND**

**COMPOSITE PRESTRESSED CONCRETE**

**ALLOWABLE STRESS DESIGN AND LOAD FACTOR DESIGN METHODS**



**SECTION 3.1.1**

**PRESTRESSED CONCRETE**

**AND**

**COMPOSITE PRESTRESSED CONCRETE**

**ALLOWABLE STRESS DESIGN AND LOAD FACTOR DESIGN METHOD**

**MOMENT ANALYSIS**

**Prestressed Concrete (PSC)**  
**ASD/LFD**  
**Moment Analysis Method for Prestressed Concrete Member**

The following are descriptions of the methods used by LARS to perform ASD/LFD member moment analysis based on the **elastic stress approach**. The moment capacity is calculated by the formula in MP-a, and the available capacity is calculated by the formula in MP-b.

MP-a: Prestressed Concrete Member - Moment Capacity

For a prestressed concrete member analyzed with the elastic stress approach, the maximum moment strength at the section  $M_u$  is calculated as follows, in accordance with Bridge Specification 9.15.2.2:

$$M_u = CAP_{AVAIL} \pm M_{dl} \pm M_{sdl}$$

MP-b: Prestressed Concrete Member - Available Capacity for LL + IMP

For a prestressed concrete member analyzed with the elastic stress approach, the value of the available capacity for LL + IMP moment at the section is calculated as follows:

Bending Positive - Top  $CAP_{AVAIL} = \left[ 0.6f'_c + \left( -\frac{F_f}{A} + \frac{F_f e}{S_t^+} - \frac{M_{dl}}{S_t^+} - \frac{M_{sdl}}{S_{t(n=3n)}^+} \right) \right] S_{t(n=n)}^+$

or  $CAP_{AVAIL} = \left[ 0.4f'_c + \frac{1}{2} \left( -\frac{F_f}{A} + \frac{F_f e}{S_t^+} - \frac{M_{dl}}{S_t^+} - \frac{M_{sdl}}{S_{t(n=3n)}^+} \right) \right] S_{t(n=n)}^+$

Use whichever is smaller of the above.

Bending Negative - Top  $CAP_{AVAIL} = \left[ 6\sqrt{f'_c} + \frac{F_f}{A} - \frac{F_f e}{S_t^-} + \frac{M_{dl}}{S_t^-} + \frac{M_{sdl}}{S_{t(n=3n)}^-} \right] S_{t(n=n)}^-$

Bending Positive - Bottom  $CAP_{AVAIL} = \left[ 6\sqrt{f'_c} + \frac{F_f}{A} + \frac{F_f e}{S_b^+} - \frac{M_{dl}}{S_b^+} - \frac{M_{sdl}}{S_{b(n=3n)}^+} \right] S_{b(n=n)}^+$

$$\text{Bending Negative - Bottom} \quad CAP_{AVAIL} = \left[ 0.6f_c' + \left( -\frac{F_f}{A} - \frac{F_f e}{S_b^-} + \frac{M_{dl}}{S_b^-} + \frac{M_{sdl}}{S_{b(n=3n)}^-} \right) \right] S_{b(n=n)}^-$$

$$\text{or} \quad CAP_{AVAIL} = \left[ 0.4f_c' + \frac{1}{2} \left( -\frac{F_f}{A} - \frac{F_f e}{S_b^-} + \frac{M_{dl}}{S_b^-} + \frac{M_{sdl}}{S_{b(n=3n)}^-} \right) \right] S_{b(n=n)}^-$$

Use whichever is smaller of the above.

where  $F_f$  = final prestressing force  
 $A$  = PSC beam area  
 $e_c$  = distance from centroid of prestressing force to centroid of PSC beam

**Prestressed Concrete (PSC) Member Moment Analysis**  
**Based on**  
**Flexural Strength Approach**

Spec	Section	Equiv Stress Block	Reinf Index	Non P/S Reinf
9.17.2	Rectangular	Not Applicable	$\leq 0.36 \beta_1$	N
9.17.2	Rectangular	Not Applicable	$\leq 0.36 \beta_1$	Y
9.18.1	Rectangular	Not Applicable	$> 0.36 \beta_1$	Y
9.17.2	I-Shape, PSC	$\leq$ Top Compression Flange	$\leq 0.36 \beta_1$	N
9.17.2	I-Shape, PSC	$\leq$ Top Compression Flange	$\leq 0.36 \beta_1$	Y
9.18.1	I-Shape, PSC	$\leq$ Top Compression Flange	$> 0.36 \beta_1$	Y
9.17.3	I-Shape, PSC	$>$ Top Compression Flange	$\leq 0.36 \beta_1$	N
9.17.3	I-Shape, PSC	$>$ Top Compression Flange	$\leq 0.36 \beta_1$	Y
9.18.1	I-Shape, PSC	$>$ Top Compression Flange	$> 0.36 \beta_1$	Y
9.17.3	Flanged, CPS	$>$ Top Compression Flange	$\leq 0.36 \beta_1$	N
9.17.3	Flanged, CPS	$>$ Top Compression Flange	$\leq 0.36 \beta_1$	Y
9.18.1	Flanged, CPS	$>$ Top Compression Flange	$> 0.36 \beta_1$	Y
9.17.2	Flanged, CPS	$\leq$ Top Compression Flange	$\leq 0.36 \beta_1$	N
9.17.2	Flanged, CPS	$\leq$ Top Compression Flange	$\leq 0.36 \beta_1$	Y
9.18.1	Flanged, CPS	$\leq$ Top Compression Flange	$> 0.36 \beta_1$	Y

**Prestressed Concrete (PSC)**  
**ASD/LFD**  
**Moment Analysis Method for Prestressed Concrete Member**

The following are descriptions of the methods used by LARS to perform ASD/LFD member moment analysis based on the **flexural strength approach**. The member section is:

- Section: Rectangular
- Equivalent Stress Block: Not Applicable
- Reinforcement Index:  $\leq 0.36 \beta_1$
- Non-Prestressed Reinforcement: No,  $A_s = 0, A'_s = 0$

The moment capacity is calculated by the formula in PS-M1a, and the available capacity is calculated by the formula in PS-M1b.

$$\text{Equivalent Stress Block} = \frac{A_s^* f_{su}^*}{0.85(f'_c)(b)}$$

$$\text{Reinforcement Index} = \frac{P^* f_{su}^*}{f'_c}$$

**Rectangular Section with Reinforcement  $\leq 0.36 \beta_1$  - Moment Capacity**

PS-M1a:

For a rectangular section with reinforcement index  $\leq 0.36 \beta_1$  and with no non-prestressing reinforcement, the maximum moment strength at the section  $M_u$  is calculated as follows, in accordance with Bridge Specification 9.17.2:

$$M_u = \left\{ A_s^* f_{su}^* d \left[ 1 - (0.6) \frac{P^* f_{su}^*}{f'_c} \right] \right\} \phi$$

PS-M1b:

The value of the available capacity for LL + IMP moment at the section is calculated as follows:

$$CAP_{AVAIL} = \left[ \frac{M_u}{1.3} \pm M_{dl} \pm M_{sdl} \right] [F]$$

where for inventory:  $F = \frac{3}{5}$ , and

for operating and posting:  $F = 1.0$

**Prestressed Concrete (PSC)**  
**ASD/LFD**  
**Moment Analysis Method for Prestressed Concrete Member**

The following are descriptions of the methods used by LARS to perform ASD/LFD member moment analysis based on the **flexural strength approach**. The member section is:

- Section: Rectangular
- Equivalent Stress Block: Not Applicable
- Reinforcement Index:  $\leq 0.36 \beta_1$
- Non-Prestressed Reinforcement: Yes,  $A_s = 0, A'_s = 0$

The moment capacity is calculated by the formula in PS-M2a, and the available capacity is calculated by the formula in PS-M2b.

$$\text{Equivalent Stress Block} = \frac{A_s^* f_{su}^*}{0.85(f'_c)(b)} + \frac{A_s f_{sy}}{0.85(f'_c)(b)}$$

$$\text{Reinforcement Index} = \frac{p^* f_{su}^*}{f'_c} + \frac{p f_{sy}}{f'_c} \left( \frac{d_t}{d} \right) - \frac{p' f_{sy}}{f'_c}$$

Note: If there is no non-prestressed tension steel in member, the  $A_s$  and  $p$  terms will be zero. If there is no compression steel in member, the  $p'$  term will be zero.

**Rectangular Section with Reinforcement Index  $\leq 0.36 \beta_1$  and with Non-Prestressing Tension Reinforcement - Moment Capacity**

PS-M2a:

For a rectangular section with reinforcement index  $\leq 0.36 \beta_1$  and with non-prestressing tension reinforcement, the maximum moment strength at the section  $M_u$  is calculated as follows, in accordance with Bridge Specification 9.17.2:

$$M_u = \left\{ A_s^* f_{su}^* d \left[ 1 - (0.6) \left( \frac{p^* f_{su}^*}{f'_c} + \frac{d_t}{d} \left( \frac{p f_{sy}}{f'_c} \right) \right) \right] + A_s f_{sy} d_t \left[ 1 - (0.6) \left( \frac{d}{d_t} \frac{p^* f_{su}^*}{f'_c} + \frac{p f_{sy}}{f'_c} \right) \right] \right\} \phi$$

PS-M2b:

The value of the available capacity for LL + IMP moment at the section is calculated as follows:

$$CAP_{AVAIL} = \left[ \frac{M_U}{1.3} \pm M_{dl} \pm M_{sdl} \right] [F]$$

where for inventory  $F = \frac{3}{5}$ , and for operating and posting  $F = 1.0$

**Prestressed Concrete (PSC)**  
**ASD/LFD**  
**Moment Analysis Method for Prestressed Concrete Member**

The following are descriptions of the methods used by LARS to perform ASD/LFD member moment analysis based on the **flexural strength approach**. The member section is:

- Section: Rectangular
- Equivalent Stress Block: Not Applicable
- Reinforcement Index:  $> 0.36 \beta_1$
- Non-Prestressed Reinforcement: Yes

The moment capacity is calculated by the formula in PS-M3a, and the available capacity is calculated by the formula in PS-M3b.

$$\text{Equivalent Stress Block} = \frac{A_s^* f_{su}^*}{0.85(f_c')(b)} + \frac{A_s f_{sy}}{0.85(f_c')(b)} - \frac{A_s' f_{sy}}{0.85(f_c')(b)}$$

$$\text{Reinforcement Index} = \frac{p^* f_{su}^*}{f_c'} + \frac{p f_{sy}}{f_c'} \left( \frac{d_t}{d} \right) - \frac{p' f_{sy}}{f_c'}$$

Note: If there is no non-prestressed tension steel in member, the  $A_s$  and  $p$  terms will be zero.

If there is no compression steel in member, the  $A_s'$  and  $p'$  will be zero.

**Rectangular Section with Reinforcement Index Greater than  $0.36 \beta_1$  and with Non-Prestressing Reinforcement - Moment Capacity**

PS-M3a:

For a rectangular section with reinforcement index greater than  $0.36 \beta_1$  and with non-prestressing reinforcement, the maximum moment strength at the section  $M_u$  is calculated as follows, in accordance with Bridge Specification 9.18.1:

$$M_u = \left[ (0.36\beta_1 - 0.08\beta_1^2) f_c' b d^2 \right] \phi$$

PS-M3b:

The value of the available capacity for LL + IMP moment at the section is calculated as follows:

$$CAP_{AVAIL} = \left[ \frac{M_u}{1.3} \pm M_{dl} \pm M_{sdl} \right] [F]$$

where for inventory:  $F = \frac{3}{5}$ , and

for operating and posting:  $F = 1.0$

**Prestressed Concrete (PSC)  
ASD/LFD  
Moment Analysis Method for Prestressed Concrete Member**

The following are descriptions of the methods used by LARS to perform ASD/LFD member moment analysis based on the **flexural strength approach**. The member section is:

- Section: I-Shape, PSC
- Equivalent Stress Block:  $\leq$  Top Compression Flange
- Reinforcement Index:  $\leq 0.36 \beta_1$
- Non-Prestressed Reinforcement: No,  $A_s = 0, A'_s = 0$

The moment capacity is calculated by the formula in PS-M4a, and the available capacity is calculated by the formula in PS-M4b.

$$\text{Equivalent Stress Block} = \frac{A_s^* f_{su}^*}{0.85(f'_c)(b_{TOPFLG})}$$

$$\text{Reinforcement Index} = \frac{A_s^*}{b_{WEB} d} \left( \frac{f_{su}^*}{f'_c} \right)$$

**Flanged Section with Values of Equivalent Stress Block  $\leq$  Top Compression Flange and with Reinforcement Index  $\leq 0.36 \beta_1$  - Moment Capacity**

PS-M4a:

For a flanged section with a value of equivalent stress block  $\leq$  top compression flange and with reinforcement index  $\leq 0.36 \beta_1$ , the maximum moment strength at the section  $M_u$  is calculated as follows, in accordance with Bridge Specification 9.17.2:

$$M_u = \left\{ A_s^* f_{su}^* d \left[ 1 - (0.6) \frac{p^* f_{su}^*}{f'_c} \right] \right\} \phi$$

PS-M4b:

The value of the available capacity for LL + IMP moment at the section is calculated as follows:

$$CAP_{AVAIL} = \left[ \frac{M_U}{1.3} \pm M_{dl} \pm M_{sdl} \right] [F]$$

where for inventory:  $F = \frac{3}{5}$ , and

for operating and posting:  $F = 1.0$



**Prestressed Concrete (PSC)  
ASD/LFD  
Moment Analysis Method for Prestressed Concrete Member**

The following are descriptions of the methods used by LARS to perform ASD/LFD member moment analysis based on the **flexural strength approach**. The member section is:

- Section: I-Shape, PSC
- Equivalent Stress Block:  $\leq$  Top Compression Flange
- Reinforcement Index:  $\leq 0.36 \beta_1$
- Non-Prestressed Reinforcement: Yes

The moment capacity is calculated by the formula in PS-M5a, and the available capacity is calculated by the formula in PS-M5b.

$$\text{Equivalent Stress Block} = \frac{A_s^* f_{su}^* + A_s f_{sy}}{0.85(f'_c)(b_{TOPFLG})}$$

$$\text{Reinforcement Index} = \frac{A_s^* f_{su}^*}{b_{WEB} d(f'_c)} + \frac{A_s f_{sy}}{b_{WEB} d_t(f'_c)} - \frac{A'_s f'_y}{b_{WEB} d'(f'_c)}$$

**Flanged Section with Value of Equivalent Stress Block  $\leq$  Top Compression Flange with Reinforcement Index  $\leq 0.36 \beta_1$ , and with Non-Prestressing Tension Reinforcement - Moment Capacity**

PS-M5a:

For a flanged section with a value of equivalent stress block  $\leq$  top compression flange, with reinforcement index  $\leq 0.36 \beta_1$ , and with non-prestressing tension reinforcement, the maximum moment strength at the section  $M_u$  is calculated as follows, in accordance with Bridge Specification 9.17.2:

$$M_u = \left\{ A_s^* f_{su}^* d \left[ 1 - (0.6) \left( \frac{p^* f_{su}^*}{f'_c} + \frac{d_t p f_{sy}}{d f'_c} \right) \right] + A_s f_{sy} d_t \left[ 1 - (0.6) \left( \frac{d}{d_t} \frac{p^* f_{su}^*}{f'_c} + \frac{p f_{sy}}{f'_c} \right) \right] \right\} \phi$$

Note: If there is no tension steel in member, the  $A_s$  and  $p$  terms will be zero.

If there is no compression steel in member, the  $p'$  term will be zero.

PS-M5b:

The value of the available capacity for LL + IMP moment at the section is calculated as follows:

$$CAP_{AVAIL} = \left[ \frac{M_u}{1.3} \pm M_{dl} \pm M_{sdl} \right] [F]$$

where for inventory:  $F = \frac{3}{5}$ , and

for operating and posting:  $F = 1.0$

**Prestressed Concrete (PSC)**  
**ASD/LFD**  
**Moment Analysis Method for Prestressed Concrete Member**

The following are descriptions of the methods used by LARS to perform ASD/LFD member moment analysis based in the **flexural strength approach**. The member section is:

- Section: I-Shape, PSC
- Equivalent Stress Block:  $\leq$  Top Compression Flange
- Reinforcement Index:  $> 0.36 \beta_1$
- Non-Prestressed Reinforcement: Yes

The moment capacity is calculated by the formula in PS-M6a, and the available capacity is calculated by the formula in PS-M6b.

$$\text{Equivalent Stress Block} = \frac{A_s^* f_{su}^*}{0.85(f'_c)(b_{TOPFLG})} + \frac{A_s f_{sy}}{0.85(f'_c)(b_{TOPFLG})}$$

$$\text{Reinforcement Index} = \frac{A_s^* f_{su}^*}{b_{WEB} d(f'_c)} + \frac{A_s f_{sy}}{b_{WEB} d_t(f'_c)} - \frac{A'_s f'_y}{b_{WEB} d'(f'_c)}$$

**Flanged Section with Value of Equivalent Stress Block  $\leq$  Top Compression Flange and with Reinforcement Index Greater than  $0.36 \beta_1$  and with Non-Prestressing Reinforcement - Moment Capacity**

PS-M6a:

For a flanged section with a value of equivalent stress block  $\leq$  top compression flange with a reinforcement index greater than  $0.36 \beta_1$  and with non-prestressing reinforcement, the maximum moment strength at the section  $M_u$  is calculated as follows, in accordance with Bridge Specification 9.18.1:

$$M_u = \left\{ \left[ (0.36\beta_1 - 0.08\beta_1^2) f'_c b d' \right] + \left[ 0.85 f'_c (b - b')(t)(d - 0.5t) \right] \right\} \phi$$

MS-M6b:

The value of the available capacity for LL + IMP moment at the section is calculated as follows:

$$CAP_{AVAIL} = \left[ \frac{M_U}{1.3} \pm M_{dl} \pm M_{sdl} \right] [F]$$

where for inventory:  $F = \frac{3}{5}$ , and

for operating and posting:  $F = 1.0$

**Prestressed Concrete (PSC)**  
**ASD/LFD**  
**Moment Analysis Method for Prestressed Concrete Member**

The following are descriptions of the methods used by LARS to perform ASD/LFD moment analysis based on the **flexural strength approach**. The member section is:

- Section: I-Shape, PSC
- Equivalent Stress Block: > Top Compression Flange
- Reinforcement Index:  $\leq 0.36 \beta_1$
- Non-Prestressed Reinforcement: No,  $A_s = 0, A'_s = 0$

The moment capacity is calculated by the formula in PS-M7a, and the available capacity is calculated by the formula in PS-M7b.

$$A_{sf} = \frac{0.85(f'_c)(b-b')_t}{f_{su}^*}$$

$$A_{sr} = A_s^* + \frac{A_s f_{sy}}{f_{su}^*} - A_{sf}$$

$$\text{Equivalent Stress Block} = \frac{A_{sr} f_{su}^*}{0.85(f'_c)(b'_{web})}$$

$$\text{Reinforcement Index} = \frac{A_{sr}}{b'd} \left( \frac{f_{su}^*}{f'_c} \right)$$

**Rectangular Section with Value of Equivalent Stress Block Greater than Top Compression, and Reinforced Index  $\leq 0.36 \beta_1$  - Moment Capacity**

PS-M7a:

For a rectangular section with a value of equivalent stress block greater than top compression and a reinforcement index less than or equal to  $0.36 \beta_1$  the maximum moment strength at the section  $M_u$  is calculated as follows, in accordance with Bridge Specification 9.17.3:

$$M_u = \left\{ A_{sr} f_{su}^* d \left[ 1 - (0.6) \left( \frac{A_{sr} f_{su}^*}{b' d f'_c} \right) \right] + 0.85 f'_c (b-b')(t)(d-0.5t) \right\} \phi$$

PS-M7b:

The value of the available capacity for LL + IMP moment at the section is calculated as follows:

$$CAP_{AVAIL} = \left[ \frac{M_u}{1.3} \pm M_{dl} \pm M_{sdl} \right] [F]$$

where for inventory:  $F = \frac{3}{5}$ , and

for operating and posting:  $F = 1.0$

**Prestressed Concrete (PSC)**  
**ASD/LFD**  
**Moment Analysis Method for Prestressed Concrete Member**

The following are descriptions of the methods used by LARS to perform ASD/LFD member moment analysis based on the **flexural strength approach**. The member section is:

- Section: I-Shape, PSC
- Equivalent Stress Block: > Top Compression Flange
- Reinforcement Index:  $\leq 0.36 \beta_1$
- Non-Prestressed Reinforcement: Yes,  $A_s = 0, A'_s = 0$

The moment capacity is calculated by the formula in PS-M8a, and the available capacity is calculated by the formula in PS-M8b.

$$A_{sf} = \frac{0.85(f'_c)(b-b')_t}{f_{su}^*}$$

$$A_{sr} = A_s^* + \frac{A_s f_{sy}}{f_{su}^*} - A_{sf}$$

$$\text{Equivalent Stress Block} = \frac{A_{sr} f_{su}^* + A_s f_{sy}}{0.85(f'_c)(b'_{web})}$$

$$\text{Reinforcement Index} = \frac{A_{sr}}{b'd} \left( \frac{f_{su}^*}{f'_c} \right) + \frac{A_s f_{sy}}{b'd_t(f'_c)} - \frac{A'_s f'_y}{b'd'(f'_c)}$$

**Rectangular Section with Value of Equivalent Stress Block Greater than Top Compression and Reinforcement Index  $\leq 0.36 \beta_1$  and with Non-Prestressing Reinforcement - Moment Capacity**

PS-M8a:

For a rectangular section with a value of equivalent stress block greater than the top compression and reinforced index less than or equal to  $0.36 \beta_1$  and with non-prestressing reinforcement, the maximum moment strength at the section,  $M_u$  is calculated as follows, in accordance with Bridge Specification 9.17.3:

$$M_u = \left\{ A_{sr} f_{su}^* d \left[ 1 - (0.6) \left( \frac{A_{sr} f_{su}^*}{b' d f'_c} \right) \right] + A_s f_{sy} (d_t - d) + 0.85 f'_c (b - b') (t) (d - 0.5t) \right\} \phi$$

PS-M8b:

The value of the available capacity for LL + IMP moment at the section is calculated as follows:

$$CAP_{AVAIL} = \left[ \frac{M_u}{1.3} \pm M_{dl} \pm M_{sdl} \right] [F]$$

where for inventory  $F = \frac{3}{5}$ , and

for operating and posting  $F = 1.0$

**Prestressed Concrete (PSC)**  
**ASD/LFD**  
**Moment Analysis Method for Prestressed Concrete Member**

The following are descriptions of the methods used by LARS to perform ASD/LFD member moment analysis based on **flexural strength approach**. The member section is:

- Section: I-Shape, PSC
- Equivalent Stress Block: > Top Compression Flange
- Reinforcement Index: > 0.36 β<sub>1</sub>
- Non-Prestressed Reinforcement: Yes

The moment capacity is calculated by the formula in PS-M9a, and the available capacity is calculated by the formula in PS-M9b.

$$A_{sf} = \frac{0.85(f'_c)(b - b')_t}{f_{su}^*}$$

$$A_{sr} = A_s^* + \frac{A_s f_{sy}}{f_{su}^*} - A_{sf}$$

$$\text{Equivalent Stress Block} = \frac{A_{sr} f_{su}^* + A_s f_{sy}}{0.85(f'_c)(b'_{web})}$$

$$\text{Reinforcement Index} = \frac{A_{sr} f_{su}^*}{b' d (f'_c)} + \frac{A_s f_{sy}}{b' d_t (f'_c)} - \frac{A'_s f'_y}{b' d' (f'_c)}$$

**Rectangular Section with Value of Equivalent Stress Block > Top Compression Flange and Reinforcement Index > 0.36 β<sub>1</sub> and Non-Prestressing Reinforcement - Moment Capacity**

PS-M9a:

For a rectangular section with a value of equivalent stress block greater than the top compression flange and a reinforcement index greater than 0.36 β<sub>1</sub> and with non-prestressing reinforcement, the maximum moment strength at the section,  $M_u$  is calculated as follows, in accordance with Bridge Specification 9.18.1:

$$M_u = \left\{ \left[ (0.36\beta_1 - 0.08\beta_1^2) f'_c b' d^2 \right] + 0.85 f'_c (b - b')(t) \left( d - \frac{t}{2} \right) \right\} \phi$$

PS-M9b:

The value of the available capacity for LL + IMP moment is calculated as follows:

$$CAP_{AVAIL} = \left[ \frac{M_u}{1.3} \pm M_{dl} \pm M_{sdl} \right] [F]$$

where for inventory:  $F = \frac{3}{5}$ , and for operating and posting:  $F = 1.0$

**Composite Prestressed Concrete (CPS)**  
**ASD/LFD**  
**Moment Analysis Method for Prestressed Concrete Member**

The following are descriptions of the methods used by LARS to perform ASD/LFD member moment analysis based on the **flexural strength approach**. The member section is:

- Section: Flanged, Composite Prestressed
- Equivalent Stress Block: >Top Compression Flange
- Reinforcement Index:  $\leq 0.36 \beta_1$
- Non-Prestressed Reinforcement: No,  $A_s = 0, A'_s = 0$

The moment capacity is calculated by the formula in CP-M1a, and the available capacity is calculated by the formula in CP-M1b.

$$A_{sf} = \frac{0.85(f'_c)_{SLAB}(b - b_{TOPFLG})t_{SLAB}}{f_{su}^*}$$

$$A_{sr}^* = A_s^* + \frac{A_s f_{sy}}{f_{su}^*} - A_{sf}$$

$$\text{Equivalent Stress Block} = \frac{A'_{sr} f_{su}^*}{0.85(f'_c)(b_{TOPFLG})}$$

$$\text{Reinforcement Index} = \frac{A_{sr} f_{su}^*}{(b_{TOPFLG} d) f'_c}$$

**Flanged Section with Value of Equivalent Stress Block > Top Compression Flange and Reinforcement Index  $\leq 0.36 \beta_1$  - Moment Capacity**

CP-M1a:

For a flanged section with a value of equivalent stress block greater than top compression flange, and reinforcement index less than or equal to  $0.36 \beta_1$ , the maximum moment strength at the section,  $M_u$  is calculated as follows, in accordance with Bridge Specification 9.17.3:

$$M_u = \left\{ A'_{sr} f_{su}^* d \left[ 1 - (0.6) \left( \frac{A'_{sr} f_{su}^*}{b_{TOPFLG} d f'_c} \right) \right] + 0.85 f'_{cSLAB} (b - b_{TOPFLG}) (t_{SLAB}) (d - 0.5 t_{SLAB}) \right\} \phi$$

CP-M1b:

The value of the available capacity for LL + IMP moment at the section is calculated as follows:

$$CAP_{AVAIL} = \left[ \frac{M_u}{1.3} \pm M_{dl} \pm M_{sdl} \right] [F]$$

where for inventory:  $F = \frac{3}{5}$ , and for operating and posting:  $F = 1.0$

**Composite Prestressed Concrete (CPS)**  
**ASD/LFD**  
**Moment Analysis Method for Prestressed Concrete Member**

The following are descriptions of the methods used by LARS to perform ASD/LFD member moment analysis based on the **flexural strength approach**. The member section is:

- Section: Flanged, Composite Prestressed
- Equivalent Stress Block: > Top Compression Flange
- Reinforcement Index:  $\leq 0.36 \beta_1$
- Non-Prestressed Reinforcement: Yes

The moment capacity is calculated by the formula in CP-M2a, and the available capacity is calculated by the formula in CP-M2b.

$$A_{sf} = \frac{0.85(f'_{c\ SLAB})(b - b_{TOPFLG})t_{SLAB}}{f_{su}^*}$$

$$A_{sr} = A_s^* + \frac{A_s f_{sy}}{f_{su}^*} - A_{sf}$$

$$\text{Equivalent Stress Block} = \frac{A'_{sr} f_{su}^* + A_s f_{sy}}{0.85(f'_c)(b'_{TOPFLG})}$$

$$\text{Reinforcement Index} = \frac{A'_{sr} f_{su}^*}{(b_{TOPFLG}d)f'_c} + \frac{A_s f_{sy}}{b_{TOPFLG}d_i f'_c} - \frac{A'_s f'_{sy}}{b_{TOPFLG}d' f'_c}$$

**Flanged Section with Value of Equivalent Stress Block > Top Compression Flange and with Reinforcement Index  $\leq 0.36 \beta_1$ , and with Non-Prestressing Reinforcement - Moment Capacity**

CP-M2a:

For a flanged section with a value of equivalent stress block greater than the top compression, and reinforcement index less than or equal to  $0.36 \beta_1$  and with non-prestressing reinforcement, the maximum moment strength at the section,  $M_u$  is calculated as follows, in accordance with Bridge Specification 9.17.3:

$$M_u = \left\{ A'_{sr} f_{su}^* d \left[ 1 - (0.6) \left( \frac{A'_{sr} f_{su}^*}{b_{TOPFLG} d f'_c} \right) \right] + 0.85 f'_{c\ SLAB} (b - b_{TOPFLG}) (t_{SLAB}) (d - 0.5 t_{SLAB}) + A_s f_{sy} (d_t - d) \right\} \phi$$

CP-M2b:

The value of the available capacity for LL + IMP moment at the section is calculated as follows:

$$CAP_{AVAIL} = \left[ \frac{M_u}{1.3} \pm M_{dl} \pm M_{sdl} \right] [F]$$

where for inventory:  $F = \frac{3}{5}$ , and for operating and posting:  $F = 1.0$

**Composite Prestressed Concrete (CPS)**  
**ASD/LFD**  
**Moment Analysis Method for Prestressed Concrete Member**

The following are descriptions of the methods used by LARS to perform ASD/LFD member moment analysis based on the **flexural strength approach**. The member section is:

- Section: Flanged, Composite Prestressed
- Equivalent Stress Block: > Top Compression Flange
- Reinforcement Index: > 0.36  $\beta_1$
- Non-Prestressed Reinforcement: Yes

The moment capacity is calculated by the formula in CP-M3a, and the available capacity is calculated by the formula in CP-M3b.

$$A_{sf} = \frac{0.85(f'_{c\ SLAB})(b - b_{TOPFLG})t_{SLAB}}{f_{su}^*}$$

$$A_{sr} = A_s^* + \frac{A_s f_{sy}}{f_{su}^*} - A_{sf}$$

$$\text{Equivalent Stress Block} = \frac{A_{sr} f_{su}^* + A_s f_{sy}}{0.85(f'_c)(b_{TOPFLG})}$$

$$\text{Reinforcement Index} = \frac{A_{sr} f_{su}^*}{(b_{TOPFLG}d)f'_c} + \frac{A_s f_{sy}}{b_{TOPFLG}d_i f'_c} - \frac{A'_s f'_{sy}}{b_{TOPFLG}d f'_c}$$

**Flanged Section with Value of Equivalent Stress Block > Top Compression Flange and Reinforcement Index > 0.36  $\beta_1$  and with Non-Prestressing Reinforcement - Moment Capacity**

CP-M3a:

For a flanged section with a value of equivalent stress block greater than the top compression flange, and a reinforcement index greater than 0.36  $\beta_1$  and with non-prestressing reinforcement, the maximum moment strength at the section  $M_u$  is calculated as follows, in accordance with Bridge Specification 9.18.1:

$$M_u = \left\{ \left[ (0.36\beta_1 - 0.08\beta_1^2) f'_c b_{TOPFLG} d^2 \right] + \left[ 0.85 f'_{c\ SLAB} (b_{SLAB} - b_{TOPFLG}) t_{SLAB} (d - 0.5t_{SLAB}) \right] \right\} \phi$$

CP-M3b:

The value of the available capacity for LL + IMP moment is calculated as follows:

$$CAP_{AVAIL} = \left[ \frac{M_u}{1.3} \pm M_{dl} \pm M_{sdl} \right] [F]$$

where for inventory:  $F = \frac{3}{5}$ , and for operating and posting:  $F = 1.0$



**Composite Prestressed Concrete (CPS)**  
**ASD/LFD**  
**Moment Analysis Method for Prestressed Concrete Member**

The following are descriptions of the methods used by LARS to perform ASD/LFD member moment analysis based on the **flexural strength approach**. The member section is:

- Section: Flanged, Composite Prestressed
- Equivalent Stress Block:  $\leq$  Top Compression Flange
- Reinforcement Index:  $\leq 0.36 \beta_1$
- Non-Prestressed Reinforcement: No,  $A_s = 0, A'_s = 0$

The moment capacity is calculated by the formula in CP-M4a, and the available capacity is calculated by the formula in CP-M4b.

$$\text{Equivalent Stress Block} = \frac{A_s^* f_{su}^*}{0.85(f'_{cSLAB})(b_{SLAB})}$$

$$\text{Reinforcement Index} = \frac{A_s^*}{b_{TOPFLG} d} \left( \frac{f_{su}^*}{f'_c} \right)$$

**Flanged Section, Composite Prestressed, with Value of Equivalent Stress Block  $\leq$  Top Compression Flange and Reinforcement  $\leq 0.36 \beta_1$  - Moment Capacity**

CP-M4a:

For a flanged section, where the composite slab acts as the flange, with a value of equivalent stress block  $\leq$  top compression flange and reinforcement index  $\leq 0.36 \beta_1$  and with non-prestressing reinforcement, the maximum moment strength at the section  $M_u$  is calculated as follows, in accordance with Bridge Specification 9.17.2:

$$M_u = \left\{ A_s^* f_{su}^* d \left[ 1 - (0.6) \frac{P^* f_{su}^*}{f'_{cSLAB}} \right] \right\} \phi$$

CP-M4b:

For a flanged section with a value of equivalent stress block  $\leq$  top compression flange and reinforcement index  $\leq 0.36 \beta_1$  and with non-prestressing reinforcement, the value of the available capacity for LL + IMP moment at the section is calculated as follows:

$$CAP_{AVAIL} = \left[ \frac{M_u}{1.3} \pm M_{dl} \pm M_{sdl} \right] [F]$$

where for inventory:  $F = \frac{3}{5}$ , and

for operating and posting:  $F = 1.0$

**Composite Prestressed Concrete (CPS)**  
**ASD/LFD**  
**Moment Analysis Method for Prestressed Concrete Member**

The following are descriptions of the methods used by LARS to perform ASD/LFD member moment analysis based on the **flexural strength approach**. The member section is:

- Section: Flanged, Composite Prestressed
- Equivalent Stress Block:  $\leq$  Top Compression Flange
- Reinforcement Index:  $\leq 0.36 \beta_1$
- Non-Prestressed Reinforcement: Yes

The moment capacity is calculated by the formula in CP-M5a, and the available capacity is calculated by the formula in CP-M5b.

$$\text{Equivalent Stress Block} = \frac{A_s^* f_{su}^* + A_s f_{sy}}{0.85(f'_{cSLAB})(b_{SLAB})}$$

$$\text{Reinforcement Index} = \frac{A_s^*}{b_{TOPFLG} d} \left( \frac{f_{su}^*}{f'_c} \right) + \frac{A_s}{b_{TOPFLG} d_t} \left( \frac{f_{sy}}{f'_c} \right)$$

**Flanged Section, Where the Composite Slab Acts as the Flange, with Value of Equivalent Stress Block  $\leq$  Top Compression Flange and with Reinforcement Index  $\leq 0.36 \beta_1$  and with Non-Prestressing Tension Reinforcement - Moment Capacity**

CP-M5a:

For a flanged section with a value of equivalent stress block  $\leq$  top compression flange with reinforcement index  $\leq 0.36 \beta_1$  and with non-prestressing tension reinforcement, the maximum moment strength at the section  $M_u$  is calculated as follows, in accordance with Bridge Specification 9.17.2:

$$M_u = \left\{ A_s^* f_{su}^* d \left[ 1 - (0.6) \left( \frac{p^* f_{su}^*}{f'_{cSLAB}} + \frac{d_t}{d} \frac{p f_{sy}}{f'_{cSLAB}} \right) \right] + A_s f_{sy} d_t \left[ 1 - (0.6) \left( \frac{d}{d_t} \frac{p^* f_{su}^*}{f'_{cSLAB}} + \frac{p f_{sy}}{f'_{cSLAB}} \right) \right] \right\} \phi$$

Note: If there is no non-prestressed tension steel in member, the  $A_s$  and  $p$  terms will be zero.  
If there is no compression steel in member, the  $p'$  term will be zero.

CP-M5b:

The value of the available capacity for LL + IMP moment at the section is calculated as follows:

$$CAP_{AVAIL} = \left[ \frac{M_U}{1.3} \pm M_{dl} \pm M_{sdl} \right] [F]$$

where for inventory:  $F = \frac{3}{5}$ , and for operating and posting:  $F = 1.0$

**Composite Prestressed Concrete (CPS)**  
**ASD/LFD**  
**Moment Analysis Method for Prestressed Concrete Member**

The following are descriptions of the methods used by LARS to perform ASD/LFD member moment analysis based on the **flexural strength approach**. The member section is:

- Section: Flanged, Composite Prestressed
- Equivalent Stress Block:  $\leq$  Top Compression Flange
- Reinforcement Index:  $> 0.36 \beta_1$
- Non-Prestressed Reinforcement: Yes

The moment capacity is calculated by the formula in CP-M6a, and the available capacity is calculated by the formula in CP-M6b.

$$\text{Equivalent Stress Block} = \frac{A_s^* f_{su}^* + A_s f_{sy}}{0.85 (f'_{SLAB}) (b_{SLAB})}$$

$$\text{Reinforcement Index} = \frac{A_s^*}{b_{TOPFLG} d} \left( \frac{f_{su}^*}{f'_c} \right) + \frac{A_s}{b_{TOPFLG} d_t} \left( \frac{f_{sy}}{f'_c} \right)$$

**Flanged Section with Value of the Equivalent Stress Block is Not Greater than of Compression Flange and with Reinforcement Index Greater than  $0.36 \beta_1$  and with Non-Prestressing Reinforcement - Moment Capacity**

CP-M6a:

For a flanged section, where the composite slab acts as the flange, with a value of equivalent stress block  $\leq$  top compression flange and with a reinforcement index greater than  $0.36 \beta_1$  and with non-prestressing reinforcement, the maximum moment strength at the section  $M_u$  is calculated as follows, in accordance with Bridge Specification 9.18.1:

$$M_u = \left\{ \left[ (0.36\beta_1 - 0.08\beta_1^2) f'_c b d^2 \right] + \left[ 0.85 f'_{cSLAB} (b_{SLAB} - b'_{TOPFLG}) (t_{SLAB}) (d - 0.5t_{SLAB}) \right] \right\} \phi$$

CP-M6b:

The value of the available capacity for LL + IMP moment at the section is calculated as follows:

$$CAP_{AVAIL} = \left[ \frac{M_U}{1.3} \pm M_{at} \pm M_{sdl} \right] [F]$$

where for inventory:  $F = \frac{3}{5}$ , and

for operating and posting:  $F = 1.0$

**Composite Prestressed Concrete (CPS)  
ASD/LFD  
Negative Ultimate Moment**

The following are descriptions of the methods used by LARS to compute ultimate moment ( $M_u$ ) for negative bending. It is calculated only for CPS when there is more than one span and slab reinforcement is present.

$$p_{SL} = \frac{A_{SL}}{b_{BOTFLG}(d_{SL})}$$

$$a = \frac{1.4p_{SL}d_{SL}f_{sySLAB}}{f'_{cSLAB}}$$

when  $a \leq t_{BOTFLG}$

$$M_U^- = A_{SL}f_{sySLAB}d_{SL} \left[ 1 - (0.6) \left( \frac{p_{SL}f_{sySLAB}}{f'_{cSLAB}} \right) \right]$$

when  $a > t_{BOTFLG}$

$$A_{sf} = \frac{0.85(f'_{cSLAB})(b_{BOTFLG} - b')t_{FLG}}{f_{sySLAB}}$$

$$A_{SR} = A_{SLAB} - A_{SF}$$

$$M_U = A_{SR}f_{sySLAB}d_{SL} \left[ 1 - (0.6) \left( \frac{A_{SR}f_{sySLAB}}{b'(d_{SL})(f'_{cSLAB})} \right) \right] + A_{sf}f_{sySLAB} [d_{SL} - 0.5(t_{FLG})]$$

or

$$M_U = A_{SR}f_{sySLAB}d_{SL} \left[ 1 - (0.6) \left( \frac{A_{SR}f_{sySLAB}}{b'(d_{SL})(f'_{cSLAB})} \right) \right] + 0.85f'_{cBEAM} [b_{BOTFLG} - b']t_{FLG} [d_{SL} - 0.5(t_{FLG})]$$

**SECTION 3.1.2**

**PRESTRESSED CONCRETE**

**AND**

**COMPOSITE PRESTRESSED CONCRETE**

**ALLOWABLE STRESS DESIGN AND LOAD FACTOR DESIGN METHOD**

**LOW TENDON ANALYSIS**

**Prestressed Concrete (PSC)  
ASD/LFD  
Moment Analysis Method for Prestressed Concrete Member  
Low Tendon Method**

The following are descriptions of the methods used by LARS to perform ASD/LFD member moment analysis, based on the **low tendon approach**. The moment capacity is calculated by the formula in PT-M1a, and the available capacity is calculated by the formula in PT-M1b.

PT-M1a:

For a prestressed concrete member analyzed with the low tendon approach, the maximum moment strength at the section  $M_u$  is calculated as follows, in accordance with Manual Bridge Specification 6.6.3.3:

$$m = \frac{nA_s^*}{b'd} + \frac{(b-b')t}{b'd}$$

$$q = \frac{nA_s^*}{b'd} + \left[ \frac{(b-b')t}{b'd} \right] \left( \frac{t/2}{d} \right)$$

$$k = \sqrt{m^2 + 2q} - m$$

$$j = 1 - 0.42k$$

$$M_u = f_s' A_s^* j d$$

PT-M1b:

The value of the available capacity for LL + IMP moment at the section is calculated as follows:

$$(M_{CAP})_{OUTLAYER} \leq 0.9(0.85)M_u$$

$$(M_{CAP})_{CL} \leq M_u \left[ \frac{d(1-k)}{d(1-k) + a_{low}} \right]$$

Non-Composite Prestressed Concrete Beam (3-32A)

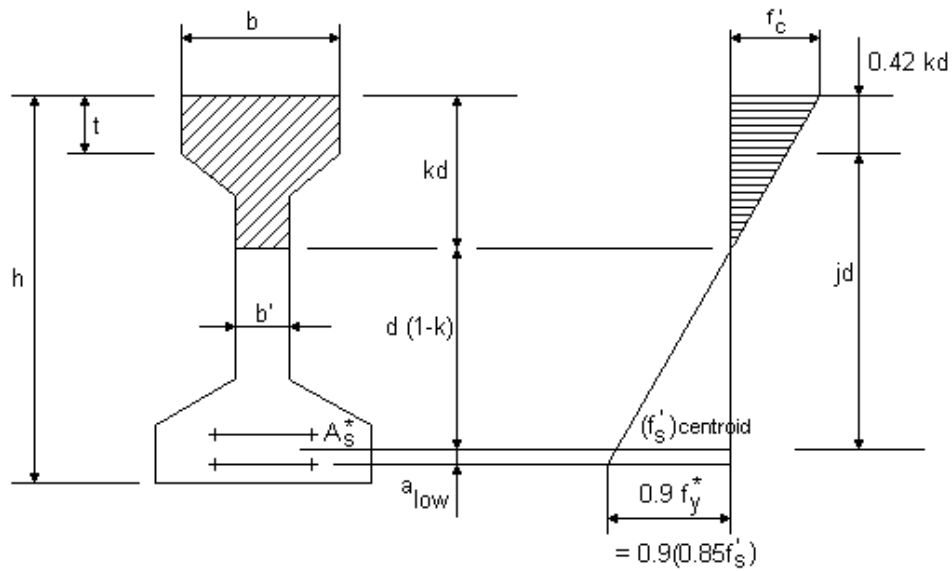

Composite Prestressed Concrete Beam (3-32B)

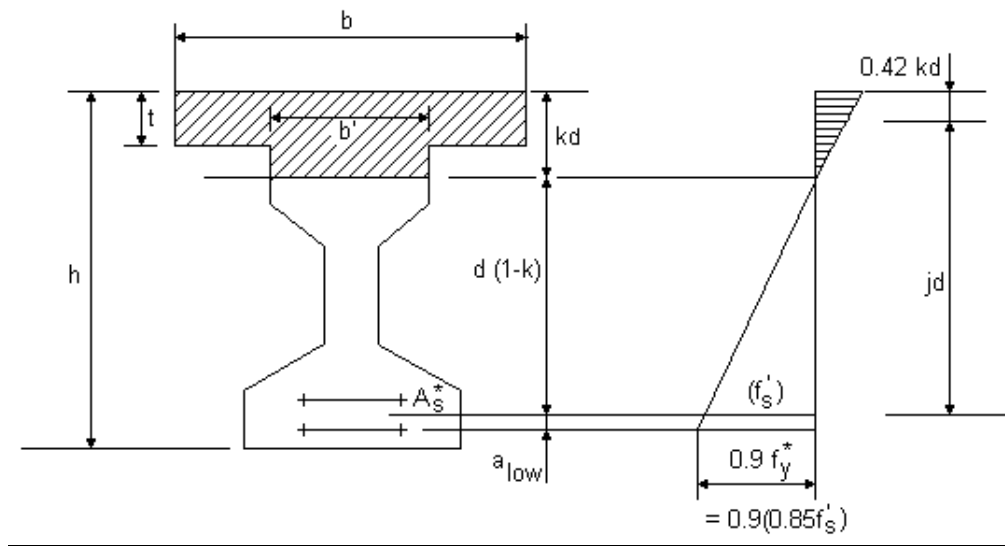

**SECTION 3.1.3**

**PRESTRESSED CONCRETE**

**AND**

**COMPOSITE PRESTRESSED CONCRETE**

**ALLOWABLE STRESS DESIGN AND LOAD FACTOR DESIGN METHODS**

**SHEAR ANALYSIS**



**Prestressed Concrete (PSC) and Prestressed Reinforced Concrete (CPS)**

**ASD/LFD**

Specification	Data Limitation *	Page
9.20.2.2	$V_{ci}$ need not be $< 1.7(\sqrt{f'_c})(b'd)$	139
9.20.2.3	In $V_{cw}$ , $d$ need not be $< 0.8h$	139
9.20.3.1	$V_s$ shall not $> 8\sqrt{f'_c}(b'd)$  1. In $V_s$ , "s" shall not exceed 0.75h or 24"  2. If $V_s > 4\sqrt{f'_c}(b'd)$ , "s" shall not exceed 0.375h or 12"  3. $Min A_v = \frac{50b'(s)}{f_{sy}}$  4. $f_{sy}$ shall not exceed 60,000	139

\* Check the above limitation. If true, issue a warning message.

**Prestressed Reinforced Concrete (CPS)  
ASD/LFD  
Shear Analysis Method for CPS Member**

The following are descriptions of the methods for LARS to perform **ASD/LFD shear analysis**. The shear capacity is calculated by the formula in VP-1a, and the available capacity is calculated by the formula in VP-1b.

**VP-1a:**

For a CPS member, the maximum shear strength at the section  $V_u$  is calculated as follows, in accordance with Bridge Specifications 9.20.2.2, 9.20.2.3, and 9.20.3.1.

**Positive Bending Regions**

$$V_{ci} = 6\sqrt{f'_c} b' d + V_d + \frac{V_{MAX} M_{cr}}{M_{MAX}} \geq 1.7\sqrt{f'_c} b' d$$

where:  $M_{cr} = S_{b(n=n)}^+ (6\sqrt{f'_c} + f_{pc} - f_d)$

$$f_{pe} = \frac{F_f}{A} + \frac{F_f e}{S_b^+}$$

$$f_d = \frac{M_{dl}}{S_b^+} \pm \frac{M_{sdl}}{S_{b(n=3n)}^+}$$

$$V_{cw} = (3.5\sqrt{f'_c} + 3f_{pc}) b' d + V_p$$

where:  $f_{pc} = \frac{F_f}{A} - \frac{F_f e (\bar{y} - C_b)}{I_x} + \frac{M_{dl} (\bar{y} - C_b)}{I_x}$

$$\bar{y} = \frac{I_{x(n=n)}}{S_b}$$

$C_b$  is for non-composite section.

$$V_c = MIN(V_{ci}, V_{cw})$$

$$V_s = \frac{A_v f_{sy} d}{S} \leq 8\sqrt{f'_c} b' d$$

where:  $d \geq 8h$

$$V_u = 0.9(V_c + V_s)$$

Negative Bending Regions

$$V_c = \left[ 1.9\sqrt{f'_c} + 2500\rho_w \left( \frac{V_{MAX}d'}{M_{MAX}} \right) \right] b'd' \leq 3.5\sqrt{f'_c} b'd'$$

where: 
$$\rho_w = \frac{A_s \left( \text{excluding tension re-steel} \right)}{b'd'}$$

$$V_s = \frac{A_v f_{sy} d'}{S} \leq 8\sqrt{f'_c} (b')d'$$

$$V_u = 9(V_c + V_s)$$

For definitions of  $d$  (positive bending) and  $d'$  (negative bending), see figures below.

Composite Prestressed Concrete Shear  
Positive Moment Region (3-34C)

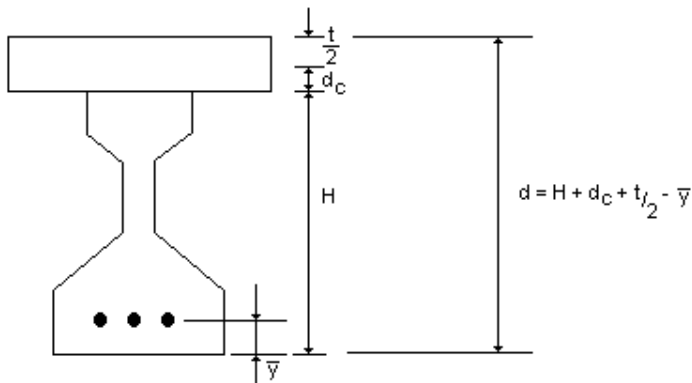

Negative Moment Region (3-34B)

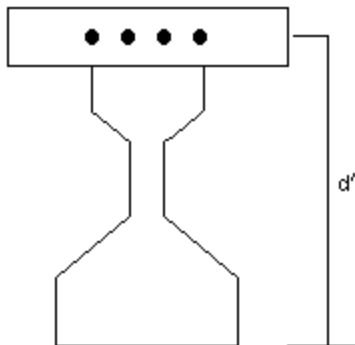

VP-1b:

The value of the available capacity for LL + IMP shear at the section is calculated as follows:

$$V_{AVAIL} = \left[ \frac{V_u}{1.3} \pm V_{DL} \pm V_{SDL} \right] [F]$$

where for inventory:  $F = \frac{3}{5}$ , and

for operating and posting:  $F = 1.0$

**SECTION 3.1.4**

**PRESTRESSED CONCRETE**

**AND**

**COMPOSITE PRESTRESSED CONCRETE**

**ALLOWABLE STRESS DESIGN AND LOAD FACTOR DESIGN METHODS**

**SERVICEABILITY MOMENT ANALYSIS**

**Prestressed Concrete and Composite Prestressed Concrete**

**Serviceability Moment Analysis**

LFD

Specification	Member	Page
M6.6.3.3	Prestressed Concrete (PSC)/Composite Prestressed Concrete (CPS)	

**Prestressed Concrete (PSC)/Composite Prestressed Concrete (CPS)  
ASD/LFD  
Serviceability Analysis Method for PSC/CPS Members**

The following are descriptions of the methods used by LARS to perform ASD/LFD member serviceability analysis when the member is of **prestressed concrete or composite prestressed concrete**. The LARS serviceability analysis is based on ductility considerations as outlined in the 1996 AASHTO Bridge Specification, Section 9.18, and the AASHTO Manual for Condition Evaluation of Bridges, 1994, Section 6.6.3.3.

PV-M1a:

For prestressed concrete or composite prestressed concrete, the maximum serviceability strength at the section  $SM_{CAP}$  is calculated as follows, in accordance with the Manual for Condition Evaluation of Bridges, 6.6.3.3:

$$SM_{CAP} = k(\phi M_n)$$

where:  $k = \frac{\phi M_n}{1.2 M_{cr}}$  (when  $\phi M_n < 1.2 M_{cr}$ , else  $k=1.0$ )

$$M_{cr} = (f_r + f_{pe})S_{(n=n)} + M_{DL} \left( \frac{S_{(n=n)}}{S} - 1 \right)$$

$$f_r = 7.5\sqrt{f'_c}$$

$$f_{pe} = \frac{F_f}{A} \pm \frac{F_f e}{S_{(n=n)}}$$

PV-M1b:

The value of the available serviceability capacity for LL + IMP moment at the section is calculated as follows:

$$CAP_{AVAIL} = SM_{CAP} \pm M_{DL} \pm M_{SDL} \quad \text{- inventory only}$$

**LRFD Prestressed Concrete Losses – Estimate Method (5.9.5)**

Total Loss for pretensioned members

$$\Delta f_{pT} = \Delta f_{pES} + \Delta f_{pLT}$$

Total Loss for post-tensioned members

$$\Delta f_{pT} = \Delta f_{pF} + \Delta f_{pA} + \Delta f_{pES} + \Delta f_{pLT}$$

Loss Type	Pretensioned	Post-tensioned
friction $\Delta f_{pF}$		$\Delta f_{pF} = f_{pj} \left(1 - \mathcal{G}^{-(Kx+\mu\alpha)}\right)$
anchorage $\Delta f_{pA}$		From plans
elastic shortening $\Delta f_{pES}$	$\Delta f_{pES} = \frac{E_p}{E_{ct}} f_{cgp}$	$\Delta f_{pES} = \left(\frac{N-1}{2N}\right) \frac{E_p}{E_{ci}} f_{cgp}$
time dependent losses – Type A $\Delta f_{pLT}$ normal weight only slabs only no-partially prestressed strands	$\Delta f_{pLT} = 10.0 \frac{f_{ps} A_{ps}}{A_g} \gamma_h \gamma_{st} + 12.0 \gamma_h \gamma_{st} + \Delta f_{pR}$ $\gamma_h = 1.7 - 0.01H$ $\gamma_{st} = \frac{5}{(1 + f'_{ci})}$ $\Delta f_{pR} = 2.4 \text{ (low\_lax), } 10.0 \text{ (stress)}$	
time dependent losses – Type B $\Delta f_{pLT}$ any members not in Type A composite prestressed partially prestressed	$\Delta f_{pLT} = 26.0 + 4.0PPR \text{ rect., solid slab}$ $\Delta f_{pLT} = 19.0 + 4.0PPR \text{ box}$ $\Delta f_{pLT} = 33.0 \left[ 1.0 - 0.15 \frac{f'_c - 6}{6} \right] + 6.0PPR \text{ T-bm, voided slab}$ $PPR = \frac{A_{ps} f_{py}}{A_{ps} f_{py} + A_s f_y}$ <p><b>NOTE:</b> For lightweight concrete – increase <math>\Delta f_{pLT}</math> by 5.0 ksi For low relaxation - decrease <math>\Delta f_{pLT}</math>: 6.0 – rect., solid slab 4.0 for box girder 8.0 for T-bm, double tee, voided slab, hollowcore sections</p>	
total loss $\Delta f_{pT}$	$\Delta f_{pT} = \Delta f_{pES} + \Delta f_{pLT}$	$\Delta f_{pT} = \Delta f_{pF} + \Delta f_{pA} + \Delta f_{pES} + \Delta f_{pLT}$



**Prestressed Concrete (PSC/CPS)**  
**LRFD**  
**Moment Analysis Method for Prestressed Concrete Member**

The following are descriptions of the methods used by LARS to perform LRFD member moment analysis based on stress distribution. The member section is:

- Section: Rectangular
- Non-Prestressed Reinforcement: No,  $A_s \neq 0, A_s' \neq 0$

The moment capacity is calculated by the formula in PS-M1a, and the available capacity is calculated by the formula in PS-M1b.

**Rectangular Section with Bonded Tendons**

PS-M1a:

For a rectangular section with bonded tendons, the maximum moment strength at the section  $M_u$  is calculated as follows, in accordance with Bridge Specification 5.7.3.2:

$$M_n = A_{ps} f_{ps} \left( d_p - \frac{a}{2} \right) + A_s f_s \left( d_s - \frac{a}{2} \right) + A_s' f_s' \left( d_s' - \frac{a}{2} \right)$$

$$f_{ps} = f_{pu} \left( 1 - k \frac{c}{d_p} \right) \quad , \quad \text{where } f_{pe} > 0.5 f_{pu}$$

$$k = 2 \left( 1.04 - \frac{f_{py}}{f_{pu}} \right)$$

Bonded tendons only:

$$c = \frac{A_{ps} f_{pu} + A_s f_y - A_s' f_y'}{0.85 f_c' \beta_1 b + k A_{ps} \frac{f_{pu}}{d_p}} \quad , \quad a = c \beta_1$$

Bonded and unbonded tendons:

$$c = \frac{A_{psb} f_{pu} + A_{psu} f_{pe} + A_s f_y - A_s' f_y'}{0.85 f_c' \beta_1 b + k A_{ps} \frac{f_{pu}}{d_p}} \quad , \quad a = c \beta_1$$

$$M_r = \phi_f M_n$$

PS-M1b:

The value of the available capacity for LL + IMP moment at the section is calculated as follows:

$$CAP_{AVAIL} = [M_r \pm (F_1 \times M_{dl}) \pm (F_2 \times M_{sdl})]$$

where:

	F1	F2	F3
Service State	DL - DC	DL – wearing surface	LL
Strength I	$\gamma_p$	$\gamma_p$	1.75
Strength II	$\gamma_p$	$\gamma_p$	1.35
Service I	1.0	1.0	1.0

NOTE:  $\gamma_p = 1.25-0.9$  for DC

$\gamma_p = 1.50-0.65$  for w.s.

**Prestressed Concrete (PSC/CPS)**  
**LRFD**  
**Moment Analysis Method for Prestressed Concrete Member**

The following are descriptions of the methods used by LARS to perform LRFD member moment analysis based on stress distribution. The member section is:

- Section: Rectangular
- Non-Prestressed Reinforcement: No,  $A_s \neq 0, A'_s \neq 0$

The moment capacity is calculated by the formula in PS-M1a, and the available capacity is calculated by the formula in PS-M1b.

**Rectangular Section with Unbonded Tendons**

PS-M2a:

For a rectangular section with bonded tendons, the maximum moment strength at the section  $M_u$  is calculated as follows, in accordance with Bridge Specification 5.7.3.1.1 and 5.7.3.1.2:

$$M_n = A_{ps} f_{ps} \left( d_p - \frac{a}{2} \right) + A_s f_s \left( d_s - \frac{a}{2} \right) + A'_s f'_s \left( d'_s - \frac{a}{2} \right)$$

$$f_{ps} = f_{pe} + 900 \left( \frac{d_p - c}{\ell_e} \right) \leq f_{py}$$

$$\ell_e = \left( \frac{2\ell_i}{2 + N_s} \right)$$

$$c = \frac{A_{ps} f_{ps} + A_s f_y - A'_s f'_y}{0.85 f'_c \beta_1 b} \quad , \quad a = c \beta_1$$

$$M_r = \phi_f M_n$$

PS-M2b:

The value of the available capacity for LL + IMP moment at the section is calculated as follows:

$$CAP_{AVAIL} = [M_r \pm (F_1 \times M_{dl}) \pm (F_2 \times M_{sdl})]$$

where:

	F1	F2	F3
Service State	DL - DC	DL – wearing surface	LL
Strength I	$\gamma_p$	$\gamma_p$	1.75

Strength II	$\gamma_p$	$\gamma_p$	1.35
Service I	1.0	1.0	1.0

NOTE:  $\gamma_p = 1.25-0.9$  for DC  
 $\gamma_p = 1.50-0.65$  for w.s.

**Prestressed Concrete (PSC/CPS)**  
**LRFD**  
**Moment Analysis Method for Prestressed Concrete Member**

The following are descriptions of the methods used by LARS to perform LRFD member moment analysis based on stress distribution. The member section is:

- Section: T-section
- Non-Prestressed Reinforcement: No,  $A_s \neq 0, A'_s \neq 0$

The moment capacity is calculated by the formula in PS-M1a, and the available capacity is calculated by the formula in PS-M1b.

**T-Section with Bonded Tendons**

PS-M3a:

For a rectangular section with bonded tendons, the maximum moment strength at the section  $M_u$  is calculated as follows, in accordance with Bridge Specification 5.7.3.1.1:

$$M_n = A_{ps} f_{ps} \left( d_p - \frac{a}{2} \right) + A_s f_s \left( d_s - \frac{a}{2} \right) + A'_s f'_s \left( d'_s - \frac{a}{2} \right) + 0.85 f'_c (b - b_w) h_f \left( \frac{a}{2} - \frac{h_f}{2} \right)$$

$$f_{ps} = f_{pu} \left( 1 - k \frac{c}{d_p} \right) \quad , \quad \text{where } f_{pe} > 0.5 f_{pu}$$

$$k = 2 \left( 1.04 - \frac{f_{py}}{f_{pu}} \right)$$

Bonded tendons only:

$$c = \frac{A_{ps} f_{pu} + A_s f_y - A'_s f'_y - 0.85 f'_c (b - b_w) h_f}{0.85 f'_c \beta b_w + k A_{ps} \frac{f_{pu}}{d_p}} \quad , \quad a = c \beta_1$$

Bonded and unbonded tendons:

$$c = \frac{A_{psb} f_{pu} + A_{psu} f_{pe} + A_s f_y - A'_s f'_y - 0.85 f'_c (b - b_w) h_f}{0.85 f'_c \beta b_w + k A_{ps} \frac{f_{pu}}{d_p}} \quad , \quad a = c \beta_1$$

$$M_r = \phi_f M_n$$

**PS-M3b:**

The value of the available capacity for LL + IMP moment at the section is calculated as follows:

$$CAP_{AVAIL} = [M_r \pm (F_1 \times M_{dl}) \pm (F_2 \times M_{sdl})]$$

where:

	F1	F2	F3
Service State	DL - DC	DL – wearing surface	LL
Strength I	$\gamma_p$	$\gamma_p$	1.75
Strength II	$\gamma_p$	$\gamma_p$	1.35
Service I	1.0	1.0	1.0

NOTE:  $\gamma_p = 1.25-0.9$  for DC  
 $\gamma_p = 1.50-0.65$  for w.s.

**Prestressed Concrete (PSC/CPS)  
LRFD  
Moment Analysis Method for Prestressed Concrete Member**

The following are descriptions of the methods used by LARS to perform LRFD member moment analysis based on stress distribution. The member section is:

- Section: T-section
- Non-Prestressed Reinforcement: No,  $A_s \neq 0, A'_s \neq 0$

The moment capacity is calculated by the formula in PS-M1a, and the available capacity is calculated by the formula in PS-M1b.

**T-Section with Unbonded Tendons**

PS-M4a:

For a rectangular section with bonded tendons, the maximum moment strength at the section  $M_u$  is calculated as follows, in accordance with Bridge Specification 5.7.3.1.1 and 5.7.3.1.2:

$$M_n = A_{ps} f_{ps} \left( d_p - \frac{a}{2} \right) + A_s f_s \left( d_s - \frac{a}{2} \right) + A'_s f'_s \left( d'_s - \frac{a}{2} \right) + 0.85 f'_c (b - b_w)_1 h_f \left( \frac{a}{2} - \frac{h_f}{2} \right)$$

$$f_{ps} = f_{pe} + 900 \left( \frac{d_p - c}{\ell_e} \right) \leq f_{py}$$

$$\ell_e = \left( \frac{2\ell_i}{2 + N_s} \right)$$

$$c = \frac{A_{ps} f_{ps} + A_s f_y - A'_s f'_y - 0.85 f'_c (b - b_w) h_f}{0.85 f'_c \beta_1 b_w}, \quad a = c \beta_1$$

$$M_r = \phi_f M_n$$

PS-M4b:

The value of the available capacity for LL + IMP moment at the section is calculated as follows:

$$CAP_{AVAIL} = [M_r \pm (F_1 \times M_{dl}) \pm (F_2 \times M_{sdl})]$$

where:

	F1	F2	F3
Service State	DL - DC	DL – wearing surface	LL

Strength I	$\gamma_p$	$\gamma_p$	1.75
Strength II	$\gamma_p$	$\gamma_p$	1.35
Service I	1.0	1.0	1.0

NOTE:  $\gamma_p = 1.25-0.9$  for DC  
 $\gamma_p = 1.50-0.65$  for w.s.



**Prestressed Concrete (PSC/CPS)**  
**LRFD**  
**Minimum Reinforcement Limit for Prestressed Concrete Member**

- The following are descriptions of the methods used by LARS to perform LRFD minimum reinforcement limit.

The cracking moment calculated by the formula in PS-M5a.

PS-M5a:

$M_{cr}$  is calculated as follows, in accordance with Bridge Specification 5.7.3.2:

$$M_{cr} = S_c (f_r + f_{cpe}) - M_{dnc} \left( \frac{S_c}{S_{nc}} - 1 \right) \geq S_c f_r$$

$$f_r = 0.37 \sqrt{f'_c}$$

$f_{cpe}$  = compressive stress in concrete due to effective prestress forces

$M_{dnc}$  = total unfactored dead load acting on noncomposite section

$M_{total}$  = factored moment for strength load combination Table 3.4.1-1

$$M_r \geq \text{lesser}(1.2 \times M_{cr} , 1.33 M_{total})$$

**SECTION 3.1.3**

**PRESTRESSED CONCRETE**

**AND**

**COMPOSITE PRESTRESSED CONCRETE**

**LOAD RESISTANCE FACTOR DESIGN METHODS**

**SHEAR ANALYSIS**

**Prestressed Concrete and Composite Prestressed Concrete (PSC/CPS)**  
**LRFD**  
**Shear Analysis Method for PSC/CPS Member**

The following are descriptions of the methods for LARS to perform LRFD shear analysis when the shear reinforcement is of **vertical stirrups** (i.e., shear reinforcement is perpendicular to the axis of the member). The shear capacity is calculated by the formula in VP-1a, and the available capacity is calculated by the formula in VP-1b.

**VP-1a:**

For a prestressed concrete member with vertical stirrups, the maximum shear strength at the section  $V_n$  is calculated as follows, in accordance with Bridge Specifications 5.8.3.4.3:

$$V_{ci} = .02\sqrt{f'_c}b_vd_v + V_d + \frac{V_iM_{cre}}{M_{MAX}} \geq 1.7\sqrt{f'_c}b_vd_v$$

where: 
$$M_{cre} = S_c \left( f_r + f_{cpe} - \frac{M_{dnc}}{S_{nc}} \right)$$

$$f_r = 0.2\sqrt{f'_c}$$

$$f_{cpe} = \frac{F_f}{A} + \frac{F_f e}{S_b^+}$$

$$V_{cw} = (0.06\sqrt{f'_c} + .3f_{pc})b_vd_v + V_p$$

where: 
$$f_{pc} = \frac{F_f}{A} - \frac{F_f e \left( \frac{-}{y} - C_b \right)}{I_x} + \frac{M_{dl} \left( \frac{-}{y} - C_b \right)}{I_x}$$

$$\frac{-}{y} = \frac{I_{x(n=n)}}{S_b}$$

$C_b$  is for non-composite section.

$$V_c = MIN(V_{ci}, V_{cw})$$

When  $V_{ci} < V_{cw}$   $\cot \theta = 1.0$

Or  $V_{ci} \geq V_{cw}$   $\cot \theta = 1.0 + 3 \left( \frac{f_{pc}}{\sqrt{f'_c}} \right)$

$$V_s = \frac{A_v f_y d_v (\cot \theta + \cot \alpha) \sin \alpha}{s}$$

lesser of:

$$V_n = V_c + V_s + V_p \text{ (for 5.8.3.4.3, } V_p = 0)$$

$$V_n = 0.25 f'_c b_v d_v + V_p \text{ (for 5.8.3.4.3, } V_p = 0)$$

VP-1b:

$$V_r = \phi_v V_n$$

VP-1c:

The value of the available capacity for LL + IMP moment at the section is calculated as follows:

$$CAP_{AVAIL} = [V_r \pm (F_1 \times V_{dl}) \pm (F_2 \times V_{sdl})]$$

where:

	F1	F2	F3
Service State	DL - DC	DL – wearing surface	LL
Strength I	$\gamma_p$	$\gamma_p$	1.75
Strength II	$\gamma_p$	$\gamma_p$	1.35
Service I	1.0	1.0	1.0

NOTE:  $\gamma_p = 1.25-0.9$  for DC  
 $\gamma_p = 1.50-0.65$  for w.s.

**SECTION 3.1.4**

**PRESTRESSED CONCRETE**

**AND**

**COMPOSITE PRESTRESSED CONCRETE**

**LOAD RESISTANCE FACTOR DESIGN METHODS**

**SERVICEABILITY ANALYSIS**

**Prestressed Concrete (PSC)/Composite Prestressed Concrete (CPS)  
LRFD  
Serviceability Analysis Method for PSC/CPS Members**

The following are descriptions of the methods used by LARS to perform LRFD member serviceability analysis when the member is of **prestressed concrete or composite prestressed concrete**. The LARS serviceability analysis uses stress values not moment values and is based on ductility considerations as outlined in the AASHTO Manual for Condition Evaluation of Bridges, 2003, Section 6.6.3.3?

PS-1a:

For prestressed concrete or composite prestressed concrete, the maximum serviceability resistance at the section  $Sf_{CAP}$  is calculated as follows, in accordance with the Manual for Condition Evaluation of Bridges, 6.6.3.3:

$$Sf_{CAP} = f_r$$

where:

$$f_r = f_{pe} + \text{Allowable tensile stress}$$

$$\text{Allowable tensile stress} = \text{Table 5.9.4.2.2-1}$$

$$f_{pe} = \frac{F_f}{A} \pm \frac{F_f e}{S_{(n=n)}}$$

PS-1b:

The value of the available serviceability resistance for LL + IMP moment at the section is calculated as follows:

$$CAP_{AVAIL} = Sf_{CAP} \pm (F_1 \times f_{DL}) \pm (F_2 \times f_{SDL}) - \text{no operating}$$

where:

	F1	F2	F3
Service State	DL - DC	DL – wearing surface	LL
Strength I	$\gamma_p$	$\gamma_p$	1.75
Strength II	$\gamma_p$	$\gamma_p$	1.35
Service I	1.0	1.0	1.0

NOTE:  $\gamma_p = 1.25-0.9$  for DC  
 $\gamma_p = 1.50-0.65$  for w.s.



**SECTION 4**

**TIMBER**



**Timber (TMB)<sup>4</sup>**

$b$	=	Width of bending member.
$d$	=	Depth of bending member.
$f_b$	=	Allowable bending stress.
$f_v$	=	Allowable shear stress.
$F$	=	Factor of rating type (inventory, operating, posting, etc.).
$V_{AVAIL}$	=	Available shear capacity for Live Load + Impact.
$V_{CAP}$	=	Shear capacity.
$V_{DL}$	=	Dead load shear at the section.
$V_{SDL}$	=	Superimposed dead load shear at the section.

---

<sup>4</sup> Selected symbols and references are based on AASHTO Standard Specifications for Highway Bridges, Sixteenth Edition, while other symbols and references are unique to LARS.

**Timber  
ASD  
Moment Analysis Method for Timber Member**

The following are descriptions of the methods used by LARS to perform ASD member moment analysis for a timber member. The moment capacity is calculated by the formula in T-M1a, and the available capacity is calculated by the formula in T-M1b.

T-M1a:

For a timber member, the maximum moment strength at the section  $M_{CAP}$  is calculated as follows, in accordance with Bridge Specification 13.6.4:

$$M_{CAP} = f_b(S)$$

T-M1b:

The value of the available capacity for LL + IMP moment at the section is calculated as follows:

$$CAP_{AVAIL} = [M_{CAP} \pm M_{dl} \pm M_{sdl}] [F] , \text{ and}$$

where for inventory:  $[F] = 1.00$ , and

for operating and posting:  $[F] = 1.33$

**Timber**  
**ASD**  
**Shear Analysis Method for Timber Member**

The following are descriptions of the methods for LARS to perform ASD shear analysis of a timber member. The shear capacity is calculated by the formula in VT-1a, and the available capacity is calculated by the formula in VT-1B.

VT-1a:

For a TMB member, the maximum shear strength at the section  $V_{CAP}$  is calculated as follows, in accordance with Bridge Specification 13.6.5.2:

$$V_{CAP} = \frac{2}{3} f_v(b)(d)$$

VT-1b:

The value of the available capacity for LL + IMP shear at the section is calculated as follows:

$$V_{AVAIL} = [V_{CAP}] [F] \pm V_{DL} \pm V_{SDL}$$

where for inventory:  $F = 1.0$ , and

for operating and posting:  $F = 1.33$

**Timber**  
**LRFD**  
**Strength Moment Analysis Method for Timber Member**

The following are descriptions of the methods used by LARS to perform LRFD member strength moment analysis for a timber member. The moment resistance is calculated by the formula in T-M1a, and the available resistance is calculated by the formula in T-M1b.

T-M1a:

For a timber member, the maximum moment strength at the section  $M_r$  is calculated as follows, in accordance with LRFD Bridge Specification 8.6.2:

$$M_r = \phi M_n$$

where:  $M_n = F_b S_x C_L$

$$\phi = 0.85$$

$$F_b = F_{bo} C_{KF} C_M (C_F \text{ or } C_v) C_{fu} C_i C_d C_\lambda$$

$F_o$  = reference design value

$$C_{KF} = \frac{2.5}{\phi} \text{ - format conversion factor}$$

$C_M = 1.0$  - wet service factor

$C_F = 1.0$  - size factor for sawn lumber

$$C_v = \left[ \left( \frac{12.0}{d} \right) \left( \frac{5.125}{b} \right) \left( \frac{21}{L} \right) \right]^a \leq 1 \text{ - volume factor for glulam}$$

lumber

$a = 0.05$  for southern pine,  $0.10$  for all other species

Use  $0.05$  as default

$C_{fu} = 1.0$  - flat use factor

$C_i = 0.8$  - incising factor

$C_d = 1.0$  - deck factor

$C_{fu} = 1.0$  - flat use factor

$C_\lambda = \text{varies with limit state}$  - time effect factor

$$E = E_o C_M C_i$$

$$C_L = \frac{1 + A}{1.9} - \sqrt{\frac{(1 + A)^2}{3.61} - \frac{A}{0.95}} \text{ - stability factor}$$

$$A = \frac{F_{bE}}{F_b} \text{ parameter for beam stability}$$

$$F_{bE} = \frac{K_{bE} E}{R_B^2}$$

$$R_B = \sqrt{\frac{L_e d}{b^2}}$$

$L_e$  = effective unbraced length

$b$  = net width

$d$  = net depth

**T-M1b:**

The value of the available resistance for LL + IMP moment at the section is calculated as follows:

$$RES_{AVAIL} = [M_r \pm (F_1 \times M_{dl}) \pm (F_2 \times M_{sdl})]$$

where:

	F1	F2	F3
Limit State	DL - DC	DL – wearing surface	LL
Strength I	$\gamma_p$	$\gamma_p$	1.75
Strength II	$\gamma_p$	$\gamma_p$	1.35
Service I	1.0	1.0	1.0

NOTE:  $\gamma_p = 1.25-0.9$  for DC  
 $\gamma_p = 1.50-0.65$  for w.s.

**Timber**  
**LRFD**  
**Strength Shear Analysis Method for Timber Member**

The following are descriptions of the methods for LARS to perform LRFD strength shear analysis of a timber member. The shear resistance is calculated by the formula in VT-1a, and the available resistance is calculated by the formula in VT-1B.

VT-1a:

For a TMB member, the maximum shear strength at the section  $V_r$  is calculated as follows, in accordance with LRFD Bridge Specification 8.7:

$$V_r = \phi V_n$$

$$\text{where: } V_n = \frac{F_v [b][d]}{1.5}$$

$$\phi = 0.75$$

$$F_v = F_{vo} C_{KF} C_M C_i C_\lambda$$

$F_o$  = reference design value

$$C_{KF} = \frac{2.5}{\phi} \text{ - format conversion factor}$$

$C_M = 1.0$  - wet service factor

$C_i = 0.8$  - incising factor

$C_L =$  - stability factor (see MT-1a)

VT-1b:

The value of the available capacity for LL + IMP shear at the section is calculated as follows:

$$CAP_{AVAIL} = [V_r \pm (F_1 \times V_{DL}) \pm (F_2 \times V_{SDL})]$$

where:

	F1	F2	F3
Limit State	DL - DC	DL – wearing surface	LL
Strength I	$\gamma_p$	$\gamma_p$	1.75
Strength II	$\gamma_p$	$\gamma_p$	1.35
Service I	1.0	1.0	1.0

NOTE:  $\gamma_p = 1.25-0.9$  for DC  
 $\gamma_p = 1.50-0.65$  for w.s.